

# Schottky Power Rectifier, Switch Mode, 10 A, 35 V

## MBRD1035CTL, NRVBD1035VCTL, SBRD81035CTL Series

The MBRD1035CTL employs the Schottky Barrier principle in a large area metal-to-silicon power diode. State of the art geometry features epitaxial construction with oxide passivation and metal overlay contact. Ideally suited for low voltage, high frequency switching power supplies, free wheeling diode and polarity protection diodes.

### Features

- Highly Stable Oxide Passivated Junction
- Guardring for Stress Protection
- Matched Dual Die Construction –  
May be Paralleled for High Current Output
- High dv/dt Capability
- Short Heat Sink Tap Manufactured – Not Sheared
- Very Low Forward Voltage Drop
- Epoxy Meets UL 94 V-0 @ 0.125 in
- SBRD8 and NRVBD Prefix for Automotive and Other Applications Requiring Unique Site and Control Change Requirements; AEC-Q101 Qualified and PPAP Capable
- These Devices are Pb-Free, Halogen Free/BFR Free and are RoHS Compliant

### Mechanical Characteristics:

- Case: Epoxy, Molded
- Weight: 0.4 Gram (Approximately)
- Finish: All External Surfaces Corrosion Resistant and Terminal Leads are Readily Solderable
- Lead and Mounting Surface Temperature for Soldering Purposes: 260°C Max. for 10 Seconds
- ESD Rating:
  - ◆ Human Body Model = 3B (> 8 kV)
  - ◆ Machine Model = C (> 400 V)



ON Semiconductor®

[www.onsemi.com](http://www.onsemi.com)

**SCHOTTKY BARRIER  
RECTIFIER  
10 AMPERES  
35 VOLTS**

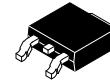

DPAK  
CASE 369C

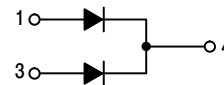

### MARKING DIAGRAM

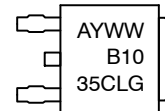

A = Assembly Location\*  
Y = Year  
WW = Work Week  
B1035CL = Device Code  
G = Pb-Free Package

\* The Assembly Location Code (A) is front side optional. In cases where the Assembly Location is stamped in the package bottom (molding ejector pin), the front side assembly code may be blank.

### ORDERING INFORMATION

See detailed ordering and shipping information in the package dimensions section on page 3 of this data sheet.

# MBRD1035CTL, NRVBD1035VCTL, SBRD81035CTL Series

## MAXIMUM RATINGS

Rating	Symbol	Value	Unit
Peak Repetitive Reverse Voltage Working Peak Reverse Voltage DC Blocking Voltage	$V_{RRM}$ $V_{RWM}$ $V_R$	35	V
Average Rectified Forward Current ( $T_C = 115^\circ\text{C}$ ) Per Leg Per Package	$I_O$	5.0 10	A
Peak Repetitive Forward Current (Square Wave, Duty = 0.5, $T_C = 115^\circ\text{C}$ ) Per Leg	$I_{FRM}$	10	A
Non-Repetitive Peak Surge Current (Surge applied at rated load conditions, halfwave, single phase, 60 Hz) Per Package	$I_{FSM}$	50	A
Storage / Operating Case Temperature	$T_{stg}, T_C$	-55 to +150	$^\circ\text{C}$
Operating Junction Temperature (Note 1)	$T_J$	-55 to +150	$^\circ\text{C}$
Voltage Rate of Change (Rated $V_R$ , $T_J = 25^\circ\text{C}$ )	dv/dt	10,000	V/ $\mu\text{s}$

Stresses exceeding those listed in the Maximum Ratings table may damage the device. If any of these limits are exceeded, device functionality should not be assumed, damage may occur and reliability may be affected.

1. The heat generated must be less than the thermal conductivity from Junction-to-Ambient:  $dP_D/dT_J < 1/R_{\theta JA}$ .

## THERMAL CHARACTERISTICS

Rating	Symbol	Value	Unit
Thermal Resistance, Junction-to-Case Per Leg	$R_{\theta JC}$	3.0	$^\circ\text{C}/\text{W}$
Thermal Resistance, Junction-to-Ambient (Note 2) Per Leg	$R_{\theta JA}$	137	$^\circ\text{C}/\text{W}$

2. Rating applies when using minimum pad size, FR4 PC Board

## ELECTRICAL CHARACTERISTICS

Rating	Symbol	Value	Unit
Maximum Instantaneous Forward Voltage (Note 3) (See Figure 2) Per Leg ( $I_F = 5$ Amps, $T_J = 25^\circ\text{C}$ ) ( $I_F = 5$ Amps, $T_J = 100^\circ\text{C}$ ) ( $I_F = 10$ Amps, $T_J = 25^\circ\text{C}$ ) ( $I_F = 10$ Amps, $T_J = 100^\circ\text{C}$ )	$V_F$	0.47 0.41 0.56 0.55	V
Maximum Instantaneous Reverse Current (Note 3) (See Figure 4) Per Leg ( $V_R = 35$ V, $T_J = 25^\circ\text{C}$ ) ( $V_R = 35$ V, $T_J = 100^\circ\text{C}$ ) ( $V_R = 17.5$ V, $T_J = 25^\circ\text{C}$ ) ( $V_R = 17.5$ V, $T_J = 100^\circ\text{C}$ )	$I_R$	2.0 30 0.20 5.0	mA

Product parametric performance is indicated in the Electrical Characteristics for the listed test conditions, unless otherwise noted. Product performance may not be indicated by the Electrical Characteristics if operated under different conditions.

3. Pulse Test: Pulse Width  $\leq 250 \mu\text{s}$ , Duty Cycle  $\leq 2.0\%$

# MBRD1035CTL, NRVBD1035VCTL, SBRD81035CTL Series

## ORDERING INFORMATION

Device	Package	Shipping†
MBRD1035CTLG	DPAK (Pb-Free)	75 Units / Rail
SBRD81035CTLG*		75 Units / Rail
SBRD81035CTLG-VF01*		75 Units / Rail
MBRD1035CTLT4G		2,500 Units / Tape & Reel
NRVBD1035VCTLT4G*		2,500 Units / Tape & Reel
SBRD81035CTLT4G*		2,500 Units / Tape & Reel

†For information on tape and reel specifications, including part orientation and tape sizes, please refer to our Tape and Reel Packaging Specifications Brochure, BRD8011/D.

\*SBRD8 and NRVBD Prefix for Automotive and Other Applications Requiring Unique Site and Control Change Requirements; AEC-Q101 Qualified and PPAP Capable.

## TYPICAL CHARACTERISTICS

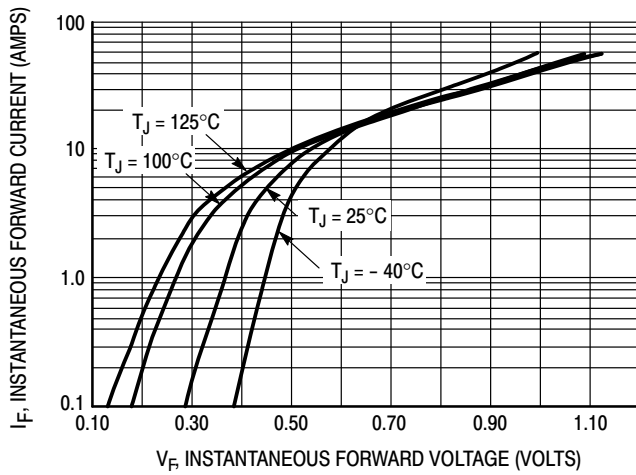

Figure 1. Typical Forward Voltage Per Leg

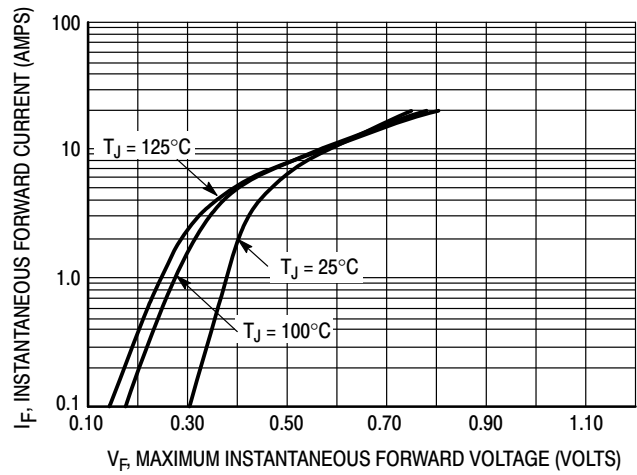

Figure 2. Maximum Forward Voltage Per Leg

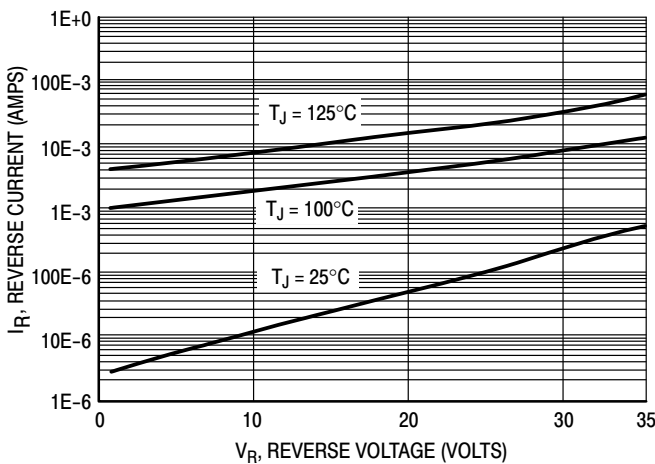

Figure 3. Typical Reverse Current Per Leg

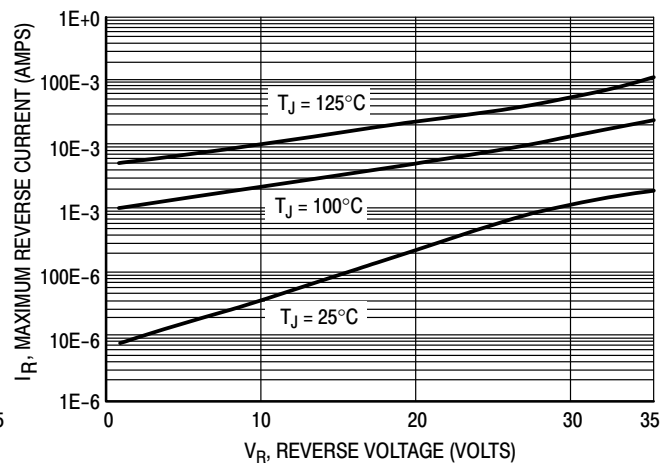

Figure 4. Maximum Reverse Current Per Leg

# MBRD1035CTL, NRVBD1035VCTL, SBRD81035CTL Series

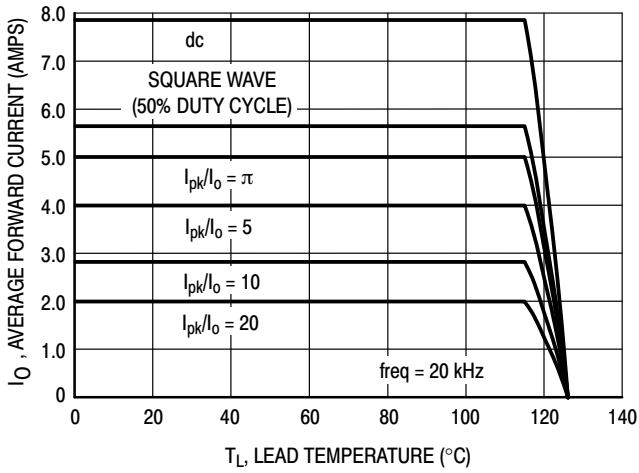

Figure 5. Current Derating Per Leg

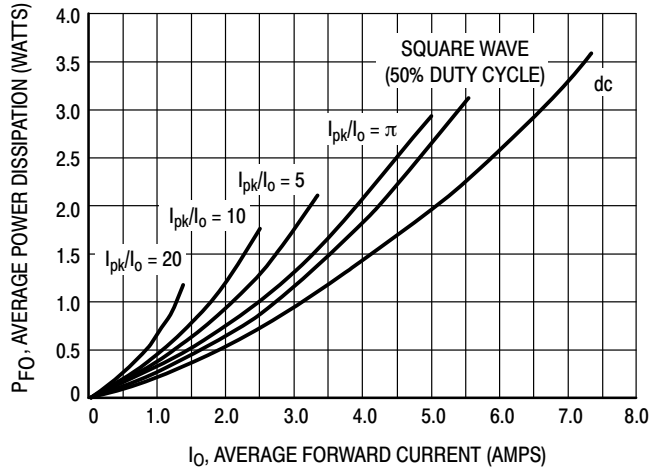

Figure 6. Forward Power Dissipation Per Leg

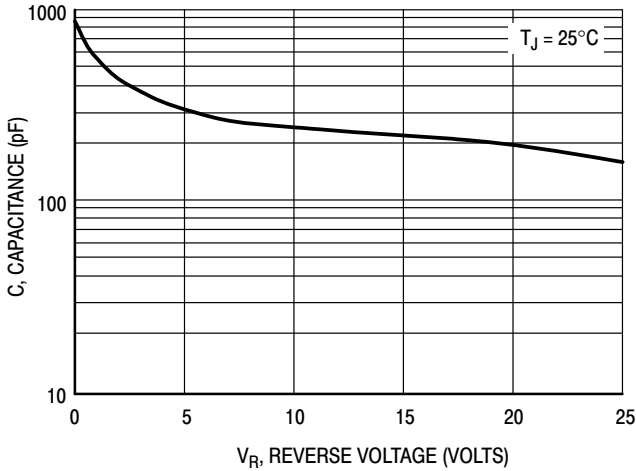

Figure 7. Capacitance Per Leg

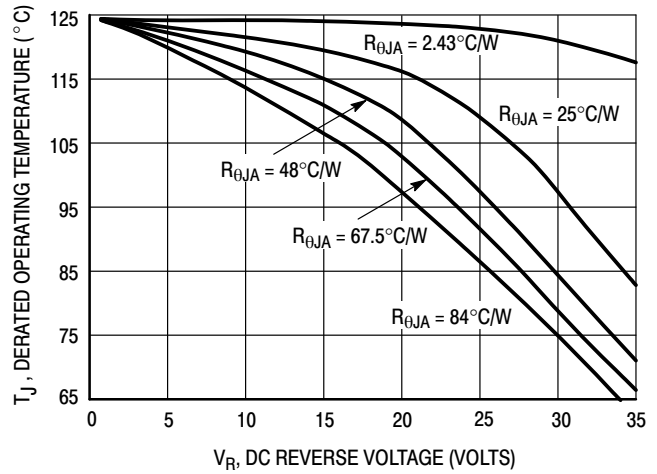

Figure 8. Typical Operating Temperature Derating Per Leg \*

\* Reverse power dissipation and the possibility of thermal runaway must be considered when operating this device under any reverse voltage conditions. Calculations of  $T_J$  therefore must include forward and reverse power effects. The allowable operating  $T_J$  may be calculated from the equation:

$$T_J = T_{Jmax} - r(t)(P_f + P_r) \text{ where}$$

$r(t)$  = thermal impedance under given conditions,  
 $P_f$  = forward power dissipation, and  
 $P_r$  = reverse power dissipation

This graph displays the derated allowable  $T_J$  due to reverse bias under DC conditions only and is calculated as  $T_J = T_{Jmax} - r(t)P_r$ , where  $r(t) = R_{thja}$ . For other power applications further calculations must be performed.

MBRD1035CTL, NRVD1035VCTL, SBRD81035CTL Series

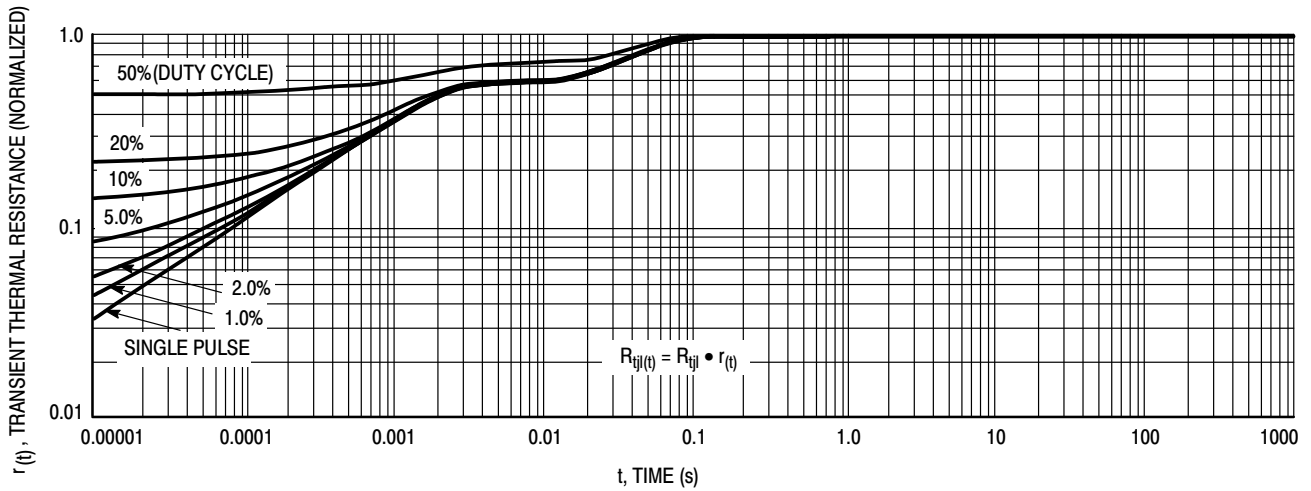

Figure 9. Thermal Response Junction to Case (Per Leg)

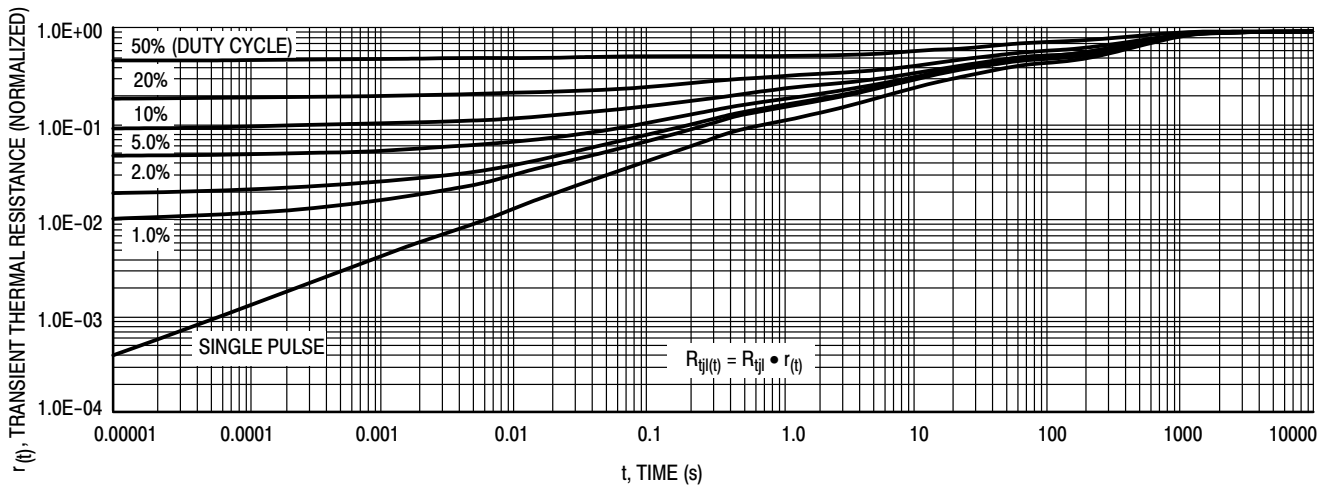

Figure 10. Thermal Response Junction to Ambient (Per Leg)

# MECHANICAL CASE OUTLINE

## PACKAGE DIMENSIONS

ON Semiconductor®



SCALE 1:1

### DPAK (SINGLE GAUGE)

#### CASE 369C

#### ISSUE F

DATE 21 JUL 2015



NOTES:

1. DIMENSIONING AND TOLERANCING PER ASME Y14.5M, 1994.
2. CONTROLLING DIMENSION: INCHES.
3. THERMAL PAD CONTOUR OPTIONAL WITHIN DIMENSIONS b3, L3 and Z.
4. DIMENSIONS D AND E DO NOT INCLUDE MOLD FLASH, PROTRUSIONS, OR BURRS. MOLD FLASH, PROTRUSIONS, OR GATE BURRS SHALL NOT EXCEED 0.006 INCHES PER SIDE.
5. DIMENSIONS D AND E ARE DETERMINED AT THE OUTERMOST EXTREMES OF THE PLASTIC BODY.
6. DATUMS A AND B ARE DETERMINED AT DATUM PLANE H.
7. OPTIONAL MOLD FEATURE.

DIM	INCHES		MILLIMETERS	
	MIN	MAX	MIN	MAX
A	0.086	0.094	2.18	2.38
A1	0.000	0.005	0.00	0.13
b	0.025	0.035	0.63	0.89
b2	0.028	0.045	0.72	1.14
b3	0.180	0.215	4.57	5.46
c	0.018	0.024	0.46	0.61
c2	0.018	0.024	0.46	0.61
D	0.235	0.245	5.97	6.22
E	0.250	0.265	6.35	6.73
e	0.090 BSC		2.29 BSC	
H	0.370	0.410	9.40	10.41
L	0.055	0.070	1.40	1.78
L1	0.114 REF		2.90 REF	
L2	0.020 BSC		0.51 BSC	
L3	0.035	0.050	0.89	1.27
L4	---	0.040	---	1.01
Z	0.155	---	3.93	---

- |  |  |   |   |  |
|--|--|---|---|--|
| <p>STYLE 1:<br/>PIN 1. BASE<br/>2. COLLECTOR<br/>3. EMITTER<br/>4. COLLECTOR</p> | <p>STYLE 2:<br/>PIN 1. GATE<br/>2. DRAIN<br/>3. SOURCE<br/>4. DRAIN</p>          | <p>STYLE 3:<br/>PIN 1. ANODE<br/>2. CATHODE<br/>3. ANODE<br/>4. CATHODE</p> | <p>STYLE 4:<br/>PIN 1. CATHODE<br/>2. ANODE<br/>3. GATE<br/>4. ANODE</p>              | <p>STYLE 5:<br/>PIN 1. GATE<br/>2. ANODE<br/>3. CATHODE<br/>4. ANODE</p>     |
| <p>STYLE 6:<br/>PIN 1. MT1<br/>2. MT2<br/>3. GATE<br/>4. MT2</p>                 | <p>STYLE 7:<br/>PIN 1. GATE<br/>2. COLLECTOR<br/>3. EMITTER<br/>4. COLLECTOR</p> | <p>STYLE 8:<br/>PIN 1. N/C<br/>2. CATHODE<br/>3. ANODE<br/>4. CATHODE</p>   | <p>STYLE 9:<br/>PIN 1. ANODE<br/>2. CATHODE<br/>3. RESISTOR ADJUST<br/>4. CATHODE</p> | <p>STYLE 10:<br/>PIN 1. CATHODE<br/>2. ANODE<br/>3. CATHODE<br/>4. ANODE</p> |

### GENERIC MARKING DIAGRAM\*

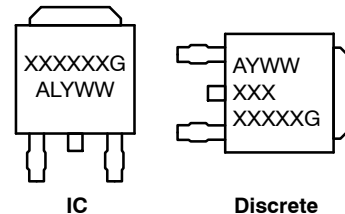

- XXXXXX = Device Code
- A = Assembly Location
- L = Wafer Lot
- Y = Year
- WW = Work Week
- G = Pb-Free Package

\*This information is generic. Please refer to device data sheet for actual part marking.

### SOLDERING FOOTPRINT\*

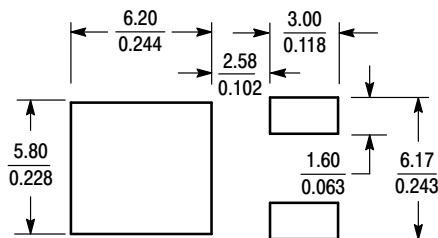

SCALE 3:1 (mm / inches)

\*For additional information on our Pb-Free strategy and soldering details, please download the ON Semiconductor Soldering and Mounting Techniques Reference Manual, SOLDERRM/D.

DOCUMENT NUMBER:	98AON10527D	Electronic versions are uncontrolled except when accessed directly from the Document Repository. Printed versions are uncontrolled except when stamped "CONTROLLED COPY" in red.
DESCRIPTION:	DPAK (SINGLE GAUGE)	PAGE 1 OF 1

ON Semiconductor and ON are trademarks of Semiconductor Components Industries, LLC dba ON Semiconductor or its subsidiaries in the United States and/or other countries. ON Semiconductor reserves the right to make changes without further notice to any products herein. ON Semiconductor makes no warranty, representation or guarantee regarding the suitability of its products for any particular purpose, nor does ON Semiconductor assume any liability arising out of the application or use of any product or circuit, and specifically disclaims any and all liability, including without limitation special, consequential or incidental damages. ON Semiconductor does not convey any license under its patent rights nor the rights of others.

**onsemi**, **Onsemi**, and other names, marks, and brands are registered and/or common law trademarks of Semiconductor Components Industries, LLC dba "**onsemi**" or its affiliates and/or subsidiaries in the United States and/or other countries. **onsemi** owns the rights to a number of patents, trademarks, copyrights, trade secrets, and other intellectual property. A listing of **onsemi**'s product/patent coverage may be accessed at [www.onsemi.com/site/pdf/Patent-Marking.pdf](http://www.onsemi.com/site/pdf/Patent-Marking.pdf). **onsemi** reserves the right to make changes at any time to any products or information herein, without notice. The information herein is provided "as-is" and **onsemi** makes no warranty, representation or guarantee regarding the accuracy of the information, product features, availability, functionality, or suitability of its products for any particular purpose, nor does **onsemi** assume any liability arising out of the application or use of any product or circuit, and specifically disclaims any and all liability, including without limitation special, consequential or incidental damages. Buyer is responsible for its products and applications using **onsemi** products, including compliance with all laws, regulations and safety requirements or standards, regardless of any support or applications information provided by **onsemi**. "Typical" parameters which may be provided in **onsemi** data sheets and/or specifications can and do vary in different applications and actual performance may vary over time. All operating parameters, including "Typicals" must be validated for each customer application by customer's technical experts. **onsemi** does not convey any license under any of its intellectual property rights nor the rights of others. **onsemi** products are not designed, intended, or authorized for use as a critical component in life support systems or any FDA Class 3 medical devices or medical devices with a same or similar classification in a foreign jurisdiction or any devices intended for implantation in the human body. Should Buyer purchase or use **onsemi** products for any such unintended or unauthorized application, Buyer shall indemnify and hold **onsemi** and its officers, employees, subsidiaries, affiliates, and distributors harmless against all claims, costs, damages, and expenses, and reasonable attorney fees arising out of, directly or indirectly, any claim of personal injury or death associated with such unintended or unauthorized use, even if such claim alleges that **onsemi** was negligent regarding the design or manufacture of the part. **onsemi** is an Equal Opportunity/Affirmative Action Employer. This literature is subject to all applicable copyright laws and is not for resale in any manner.

## PUBLICATION ORDERING INFORMATION

### LITERATURE FULFILLMENT:

Email Requests to: [orderlit@onsemi.com](mailto:orderlit@onsemi.com)

**onsemi Website:** [www.onsemi.com](http://www.onsemi.com)

### TECHNICAL SUPPORT

**North American Technical Support:**

Voice Mail: 1 800-282-9855 Toll Free USA/Canada

Phone: 011 421 33 790 2910

**Europe, Middle East and Africa Technical Support:**

Phone: 00421 33 790 2910

For additional information, please contact your local Sales Representative

# Mouser Electronics

Authorized Distributor

Click to View Pricing, Inventory, Delivery & Lifecycle Information:

[onsemi:](#)

[MBRD1035CTL](#) [MBRD1035CTLG](#) [MBRD1035CTLT4](#) [MBRD1035CTLT4G](#) [SBRD81035CTLT4G](#) [SBRD81035CTLG](#)  
[SBRD81035CTLG-VF01](#) [NRVBD1035VCTLT4G](#)