

## 650V SiC Schottky Diode

VDC	650 V
Q <sub>C</sub>	36 nC
I <sub>F</sub>	12 A
T <sub>j,max</sub>	175 °C

### Amp+™ Features

- Unipolar rectifier with surge current
- Zero reverse recovery current
- Fast, temperature-independent switching
- Avalanche tested to 80mJ\*

### Amp+™ Benefits

- Zero switching loss
- Higher efficiency
- Smaller heat sink
- Easy to parallel

### Amp+™ Applications

- Switch mode power supplies, UPS
- Power factor correction
- EV charging stations
- Output rectification

### Package

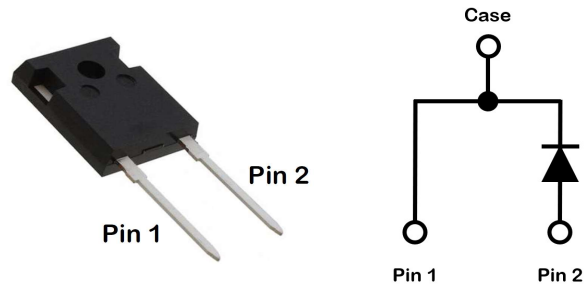

Part #	Package	Marking
GP3D012A065B	TO-247-2L	3D012A065



### Maximum Ratings, at T<sub>j</sub>=25 °C, unless otherwise specified

Characteristics	Symbol	Conditions	Values	Unit
Continuous forward current	I <sub>F</sub> **	T <sub>C</sub> =25 °C, T <sub>J</sub> =175 °C	37	A
		T <sub>C</sub> =125 °C, T <sub>J</sub> =175 °C	19	
		T <sub>C</sub> =150 °C, T <sub>J</sub> =175 °C	12	
Surge non-repetitive forward current sine halfwave	I <sub>FSM</sub>	T <sub>C</sub> =25 °C, t <sub>p</sub> =8.3 ms	120	A
		T <sub>C</sub> =110 °C, t <sub>p</sub> =8.3 ms	96	
Non-repetitive peak forward current	I <sub>F,max</sub>	T <sub>C</sub> =25 °C, t <sub>p</sub> =10 μs	720	A
i <sup>2</sup> t value	∫i <sup>2</sup> dt	T <sub>C</sub> =25 °C, t <sub>p</sub> =8.3 ms	60	A <sup>2</sup> s
		T <sub>C</sub> =110 °C, t <sub>p</sub> =8.3 ms	38	
Repetitive peak reverse voltage	V <sub>RRM</sub>	T <sub>J</sub> =25 °C	650	V
Diode dv/dt ruggedness	dv/dt	Turn-on slew rate, repetitive	200	V/ns
Power dissipation	P <sub>tot</sub> **	T <sub>C</sub> =25 °C	124	W
Operating junction & storage temperature	T <sub>j</sub> , T <sub>storage</sub>	Continuous	-55...175	°C
Soldering temperature	T <sub>solder</sub>	Wave soldering leads	260	°C
Mounting torque		M3 Screw	1	N-m

**Notes:**

\* EAS of 80 mJ is based on starting T<sub>J</sub> = 25°C, L = 1.0 mH, IAS = 12.65 A, V = 50 V.

\*\* Typical R<sub>thJC</sub> used

Electrical Characteristics, at  $T_j=25\text{ }^\circ\text{C}$ , unless otherwise specified

Characteristics	Symbol	Conditions	Values			Unit
			min.	typ.	max.	
DC blocking voltage	$V_{DC}$	$T_j=25\text{ }^\circ\text{C}$	650	-	-	V
Diode forward voltage	$V_F$	$I_F=12\text{A}, T_j=25\text{ }^\circ\text{C}$	-	1.42	1.50	V
		$I_F=12\text{A}, T_j=125\text{ }^\circ\text{C}$	-	1.49	-	
		$I_F=12\text{A}, T_j=175\text{ }^\circ\text{C}$	-	1.60	1.90	
Reverse current	$I_R$	$V_R=650\text{V}, T_j=25\text{ }^\circ\text{C}$	-	2	30	$\mu\text{A}$
		$V_R=650\text{V}, T_j=125\text{ }^\circ\text{C}$	-	14	-	
		$V_R=650\text{V}, T_j=175\text{ }^\circ\text{C}$	-	47	300	
Total capacitive charge	$Q_C$	$V_R=400\text{V}, T_j=25\text{ }^\circ\text{C}$	-	36	-	nC
Total capacitance	C	$V_R=1\text{V}, f=1\text{ MHz}$	-	572	-	pF
		$V_R=200\text{V}, f=1\text{ MHz}$	-	68	-	
		$V_R=400\text{V}, f=1\text{ MHz}$	-	57	-	

Thermal Characteristics

Characteristics	Symbol	Conditions	Values			Unit
			min.	typ.	max.	
Thermal resistance, junction-case	$R_{thJC}$	-	-	1.21	1.48	$^\circ\text{C/W}$

Typical Performance

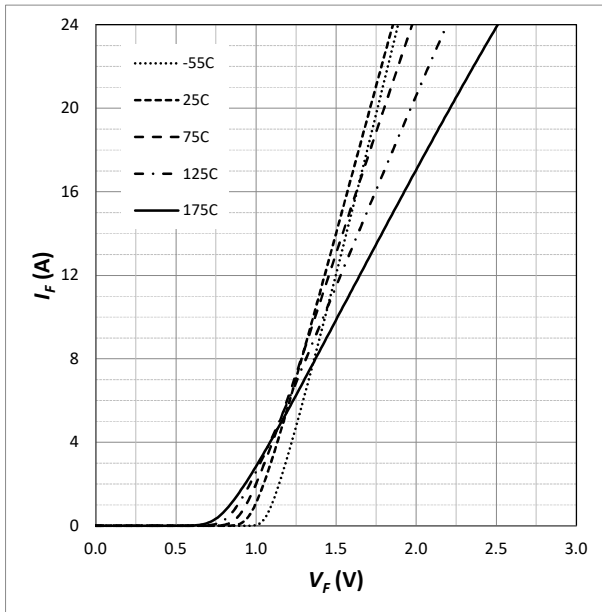

Fig. 1 Forward Characteristics (parameterized on  $T_j$ )

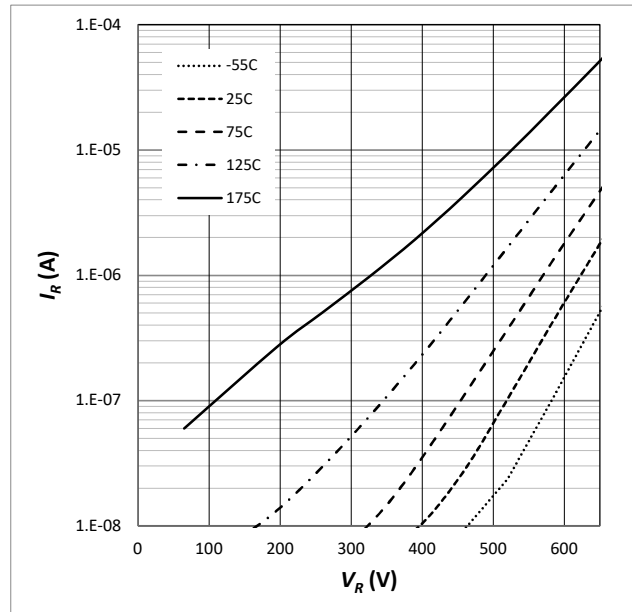

Fig. 2 Reverse Characteristics (parameterized on  $T_j$ )

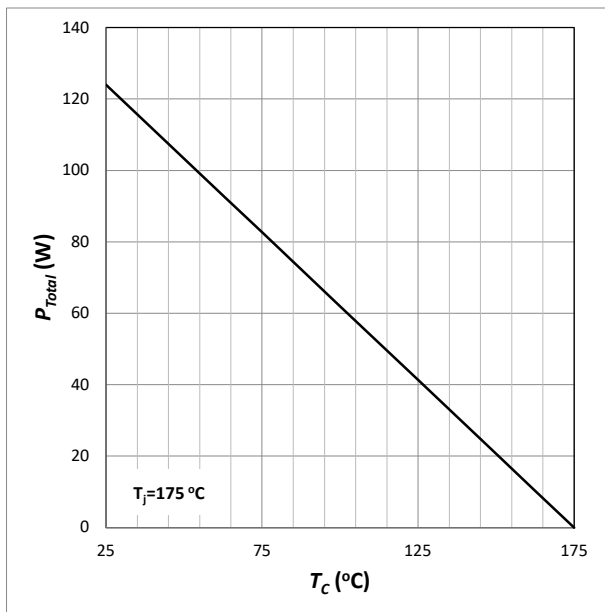

Fig. 3 Power Derating

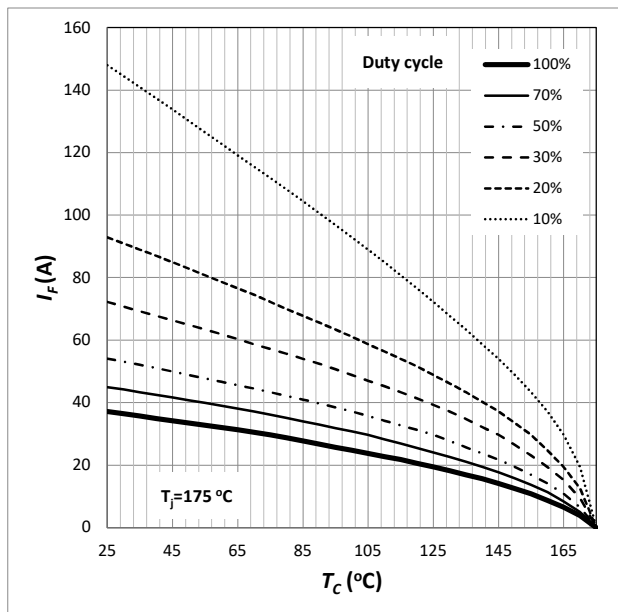

Fig. 4 Current Derating

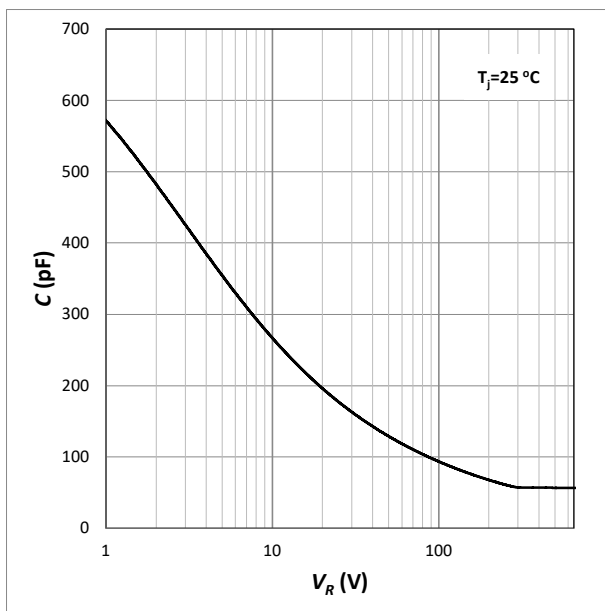

Fig. 5 Capacitance

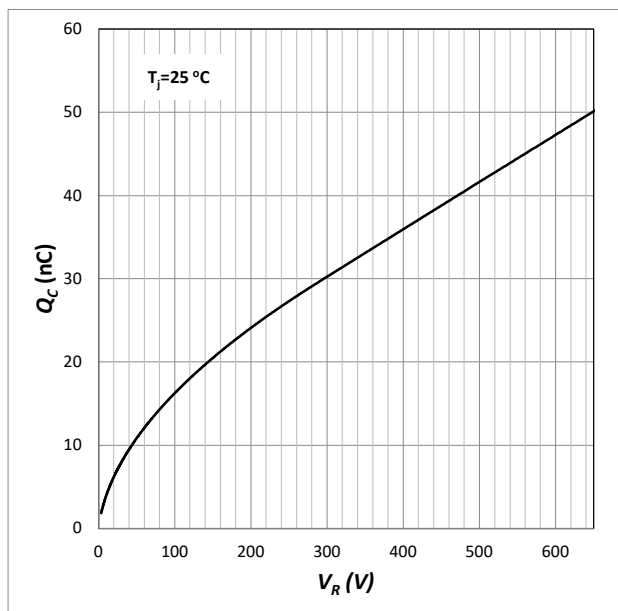

Fig. 6 Capacitive Charge

# 650V SiC Schottky Diode

Amp+™

# GP3D012A065B

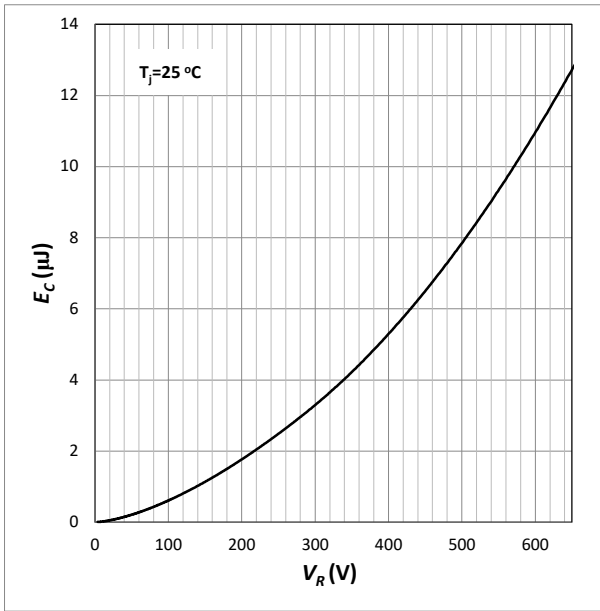

Fig. 7 Typical Capacitance Stored Energy

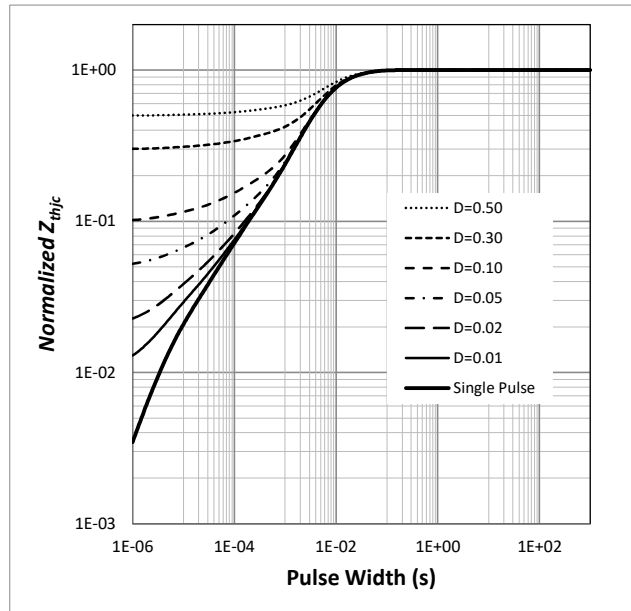
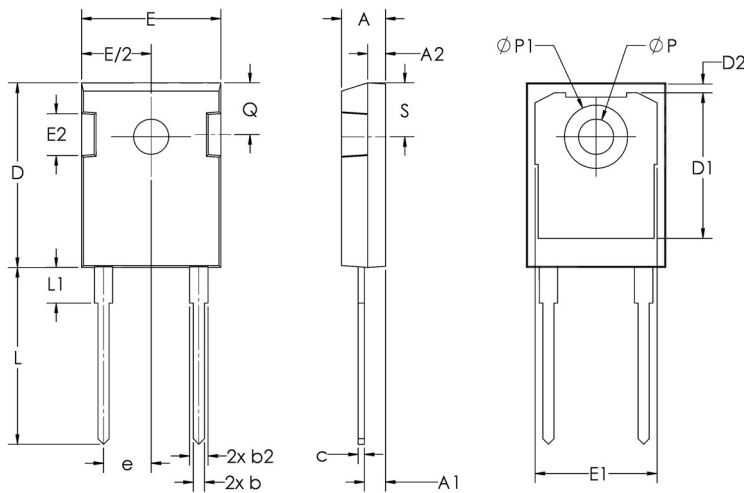

Fig. 8 Transient Thermal Impedance

## Package Dimensions TO-247-2L



Sym	Millimeters		Inches	
	Min	Max	Min	Max
A	4.70	5.31	0.185	0.209
A1	2.21	2.59	0.087	0.102
A2	1.50	2.49	0.059	0.098
b	0.99	1.40	0.039	0.055
b2	1.65	2.39	0.065	0.094
c	0.38	0.89	0.015	0.035
D	20.80	21.46	0.819	0.845
D1	13.08	17.65	0.515	0.695
D2	0.51	1.35	0.020	0.053
E	15.49	16.26	0.610	0.640
E1	13.46	14.16	0.530	0.557
E2	3.43	5.49	0.135	0.216
e	5.44 BSC		.214 BSC	
L	19.81	20.32	0.780	0.800
L1	4.10	4.50	0.161	0.177
ØP	3.56	3.66	0.140	0.144
ØP1	7.06	7.39	0.278	0.291
Q	5.38	6.20	0.212	0.244
S	6.04	6.30	0.238	0.248

## Notes

### **RoHS Compliance**

The levels of RoHS restricted materials in this product are below the maximum concentration values (also referred to as the threshold limits) permitted for such substances, or are used in an exempted application, in accordance with EU Directive 2011/65/EC (RoHS2), as implemented March, 2013. RoHS Declarations for this product can be obtained from the Product Documentation sections of [www.SemiQ.com](http://www.SemiQ.com).

### **REACH Compliance**

REACH substances of high concern (SVHC) information is available for this product. Since the European Chemicals Agency (ECHA) has published notice of their intent to frequently revise the SVHC listing for the foreseeable future, please contact our office at SemiQ Headquarters in Lake Forest, California to insure you get the most up-to-date REACH SVHC Declaration. REACH banned substance information (REACH Article 67) is also available upon request.

SemiQ Inc., reserves the right to make changes to the product specifications and data in this document without notice. SemiQ products are sold pursuant to SemiQ's terms and conditions of sale in place at the time of order acknowledgement.

This product has not been designed or tested for use in, and is not intended for use in, applications implanted into the human body nor in applications in which failure of the product could lead to death, personal injury or property damage, including but not limited to equipment used in the operation of nuclear facilities, life-support machines, cardiac defibrillators or similar emergency medical equipment, aircraft navigation or communication or control systems, or air traffic control.

SemiQ makes no warranty, representation or guarantee regarding the suitability of its products for any particular purpose, nor does SemiQ assume any liability arising out of the application or use of any product or circuit, and specifically disclaims any and all liability, including without limitation special, consequential or incidental damages. Buyer is responsible for its products and applications using SemiQ products.

To obtain additional technical information or to place an order for this product, please contact us. The information in this datasheet is provided by SemiQ. SemiQ reserves the right to make changes, corrections, modifications, and improvements of datasheet without notice.