

V_{DSS}	1200V
$R_{DS(on)}$ (Typ.)	30mΩ
I_D^{*1}	72A
P_D	339W

●Features

- 1) Qualified to AEC-Q101
- 2) Low on-resistance
- 3) Fast switching speed
- 4) Fast reverse recovery
- 5) Easy to parallel
- 6) Simple to drive
- 7) Pb-free lead plating ; RoHS compliant

●Application

- Automobile
- Switch mode power supplies

●Outline

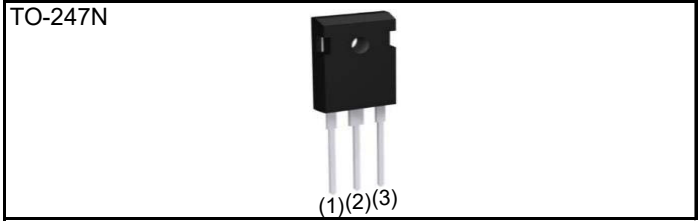

●Inner circuit

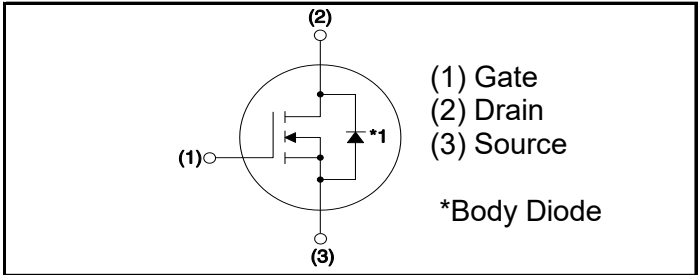

●Packaging specifications

Type	Packing	Tube
	Reel size (mm)	-
	Tape width (mm)	-
	Basic ordering unit (pcs)	30
	Taping code	C11
	Marking	SCT3030KL

●Absolute maximum ratings ($T_a = 25^\circ\text{C}$)

Parameter	Symbol	Value	Unit	
Drain - Source Voltage	V_{DSS}	1200	V	
Continuous Drain current	$T_c = 25^\circ\text{C}$	I_D^{*1}	72	A
	$T_c = 100^\circ\text{C}$	I_D^{*1}	51	A
Pulsed Drain current	$I_{D,pulse}^{*2}$	180	A	
Gate - Source voltage (DC)	V_{GSS}	-4 to +22	V	
Gate - Source surge voltage ($t_{surge} < 300\text{nsec}$)	$V_{GSS,surge}^{*3}$	-4 to +26	V	
Recommended drive voltage	$V_{GS,op}^{*4}$	0 / +18	V	
Junction temperature	T_j	175	$^\circ\text{C}$	
Range of storage temperature	T_{stg}	-55 to +175	$^\circ\text{C}$	

●Electrical characteristics ($T_a = 25^\circ\text{C}$)

Parameter	Symbol	Conditions	Values			Unit
			Min.	Typ.	Max.	
Drain - Source breakdown voltage	$V_{(BR)DSS}$	$V_{GS} = 0\text{V}, I_D = 1\text{mA}$ $T_j = 25^\circ\text{C}$ $T_j = -55^\circ\text{C}$	1200 1200	- -	- -	V
Zero Gate voltage Drain current	I_{DSS}	$V_{GS} = 0\text{V}, V_{DS} = 1200\text{V}$ $T_j = 25^\circ\text{C}$ $T_j = 150^\circ\text{C}$	- -	1 2	10 -	μA
Gate - Source leakage current	I_{GSS+}	$V_{GS} = +22\text{V}, V_{DS} = 0\text{V}$	-	-	100	nA
Gate - Source leakage current	I_{GSS-}	$V_{GS} = -4\text{V}, V_{DS} = 0\text{V}$	-	-	-100	nA
Gate threshold voltage	$V_{GS(th)}$	$V_{DS} = 10\text{V}, I_D = 13.3\text{mA}$	2.7	-	5.6	V
Static Drain - Source on - state resistance	$R_{DS(on)}^{*5}$	$V_{GS} = 18\text{V}, I_D = 27\text{A}$ $T_j = 25^\circ\text{C}$ $T_j = 150^\circ\text{C}$	- -	30 51	39 -	$\text{m}\Omega$
Gate input resistance	R_G	$f = 1\text{MHz}, \text{open drain}$	-	5	-	Ω

●Thermal resistance

Parameter	Symbol	Values			Unit
		Min.	Typ.	Max.	
Thermal resistance, junction - case	R_{thJC}	-	0.34	0.44	$^\circ\text{C/W}$

●Typical Transient Thermal Characteristics

Symbol	Value	Unit	Symbol	Value	Unit
R_{th1}	4.83E-03	K/W	C_{th1}	1.40E-03	Ws/K
R_{th2}	1.73E-01		C_{th2}	1.13E-02	
R_{th3}	1.63E-01		C_{th3}	6.02E-02	

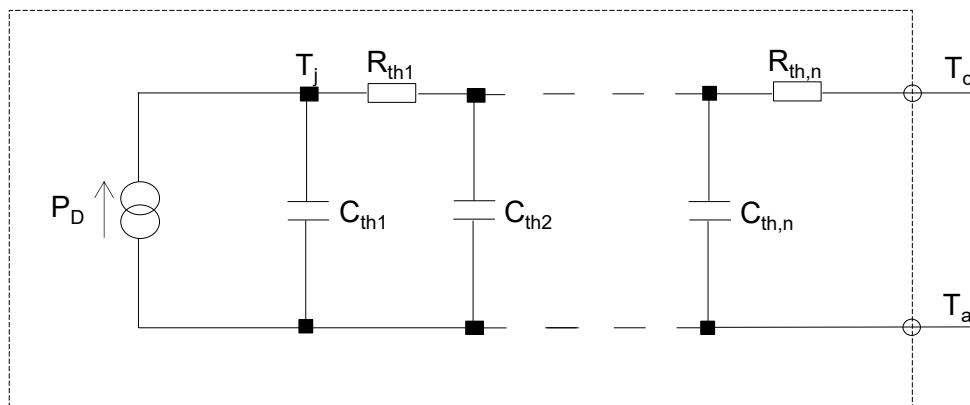

●Electrical characteristics ($T_a = 25^\circ\text{C}$)

Parameter	Symbol	Conditions	Values			Unit
			Min.	Typ.	Max.	
Transconductance	g_{fs}^{*5}	$V_{DS} = 10\text{V}, I_D = 27\text{A}$	-	10.8	-	S
Input capacitance	C_{iss}	$V_{GS} = 0\text{V}$	-	2222	-	pF
Output capacitance	C_{oss}	$V_{DS} = 800\text{V}$	-	180	-	
Reverse transfer capacitance	C_{riss}	$f = 1\text{MHz}$	-	72	-	
Effective output capacitance, energy related	$C_{o(er)}$	$V_{GS} = 0\text{V}$ $V_{DS} = 0\text{V to } 600\text{V}$	-	157	-	pF
Total Gate charge	Q_g^{*5}	$V_{DS} = 600\text{V}$ $I_D = 27\text{A}$	-	131	-	nC
Gate - Source charge	Q_{gs}^{*5}	$V_{GS} = 18\text{V}$	-	22	-	
Gate - Drain charge	Q_{gd}^{*5}	See Fig. 1-1.	-	69	-	
Turn - on delay time	$t_{d(on)}^{*5}$	$V_{DS} = 400\text{V}$ $I_D = 18\text{A}$	-	24	-	ns
Rise time	t_r^{*5}	$V_{GS} = 0\text{V}/+18\text{V}$	-	42	-	
Turn - off delay time	$t_{d(off)}^{*5}$	$R_G = 0\Omega$ $R_L = 22\Omega$	-	61	-	
Fall time	t_f^{*5}	See Fig. 1-1, 1-2.	-	29	-	
Turn - on switching loss	E_{on}^{*5}	$V_{DS} = 600\text{V}$ $V_{GS}=0\text{V}/18\text{V}, I_D = 27\text{A}$ $R_G = 0\Omega, L = 250\mu\text{H}$	-	468	-	μJ
Turn - off switching loss	E_{off}^{*5}	E_{on} includes diode reverse recovery $L_\sigma = 50\text{nH}, C_\sigma = 200\text{pF}$ See Fig. 2-1, 2-2.	-	204	-	

●Body diode electrical characteristics (Source-Drain) ($T_a = 25^\circ\text{C}$)

Parameter	Symbol	Conditions	Values			Unit
			Min.	Typ.	Max.	
Body diode continuous, forward current	I_S *1	$T_c = 25^\circ\text{C}$	-	-	72	A
Body diode direct current, pulsed	I_{SM} *2		-	-	180	A
Forward voltage	V_{SD} *5	$V_{GS} = 0\text{V}, I_D = 27\text{A}$	-	3.2	-	V
Reverse recovery time	t_{rr} *5	$I_F = 27\text{A}$ $V_R = 600\text{V}$ $di/dt = 1100\text{A}/\mu\text{s}$	-	27	-	ns
Reverse recovery charge	Q_{rr} *5		-	135	-	nC
Peak reverse recovery current	I_{rrm} *5		$L_\sigma = 50\text{nH}, C_\sigma = 200\text{pF}$ See Fig. 3-1, 3-2.	-	10	-

*1 Limited by maximum temperature allowed.

*2 $P_W \leq 10\mu\text{s}$, Duty cycle $\leq 1\%$

*3 Example of acceptable V_{GS} waveform

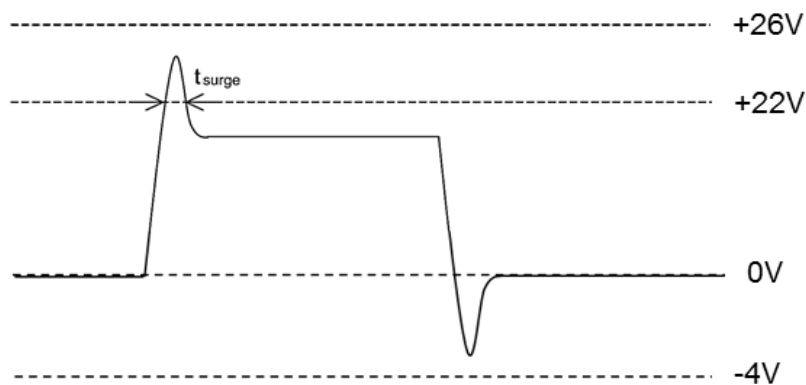

*4 Please be advised not to use SiC-MOSFETs with V_{GS} below 13V as doing so may cause thermal runaway.

*5 Pulsed

●Electrical characteristic curves

Fig.1 Power Dissipation Derating Curve

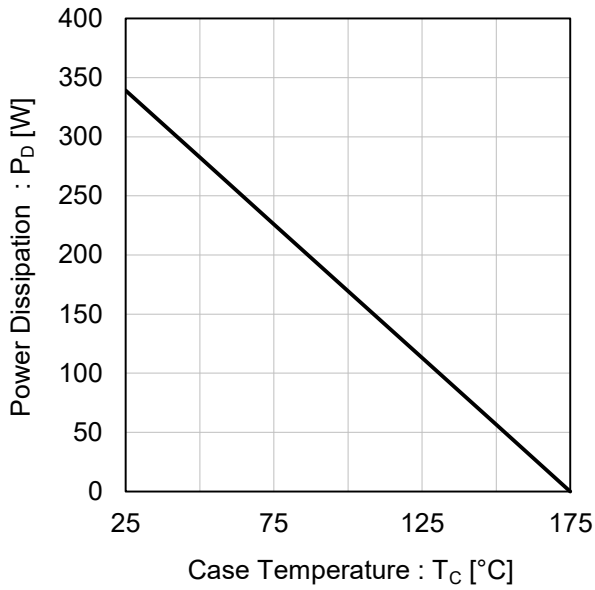

Fig.2 Maximum Safe Operating Area

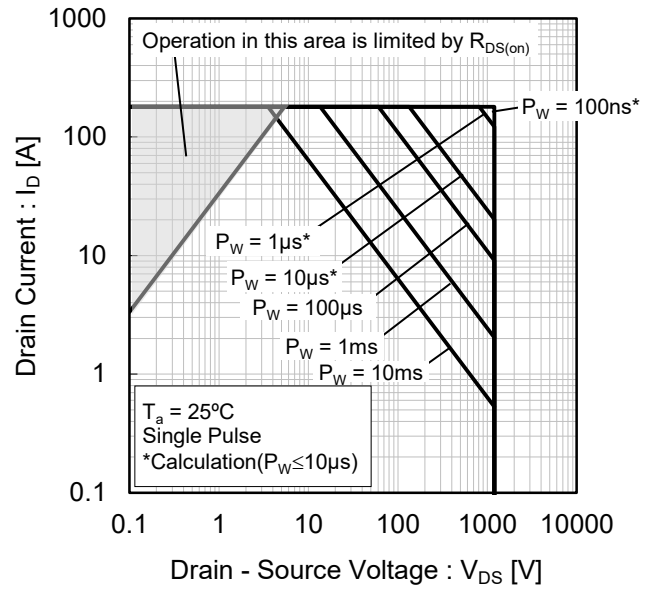
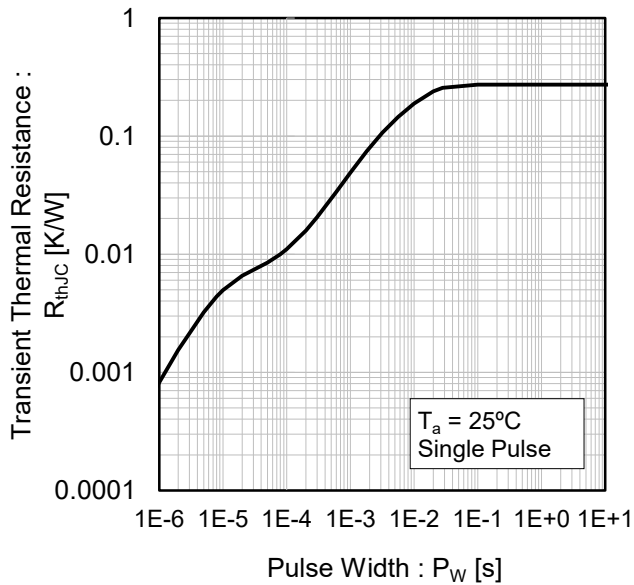

Fig.3 Typical Transient Thermal Resistance vs. Pulse Width



●Electrical characteristic curves

Fig.4 Typical Output Characteristics(I)

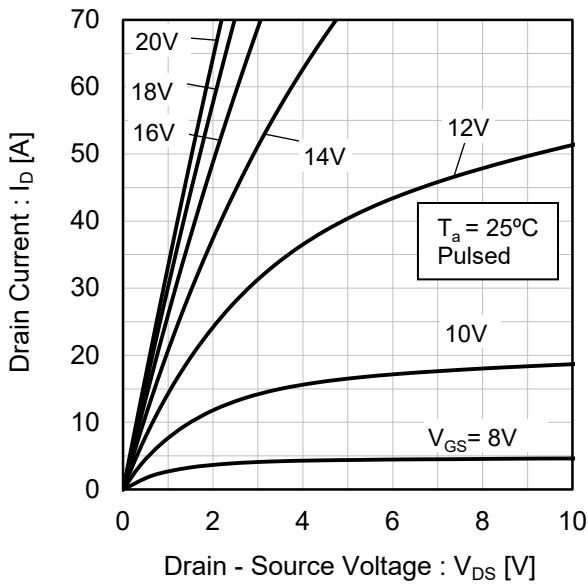

Fig.5 Typical Output Characteristics(II)

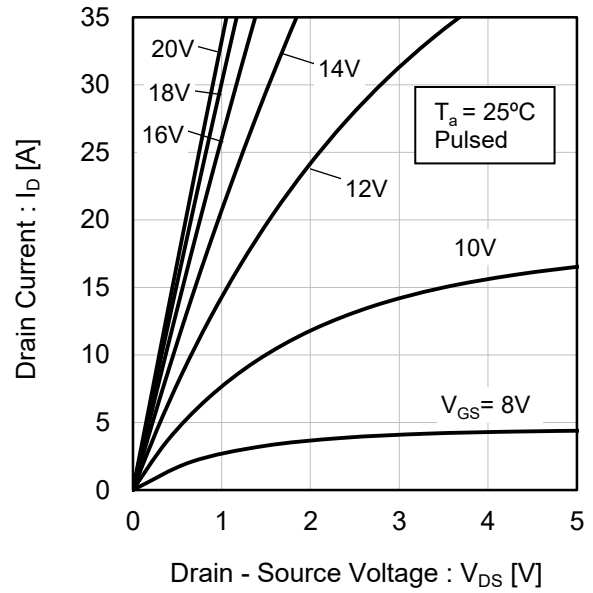
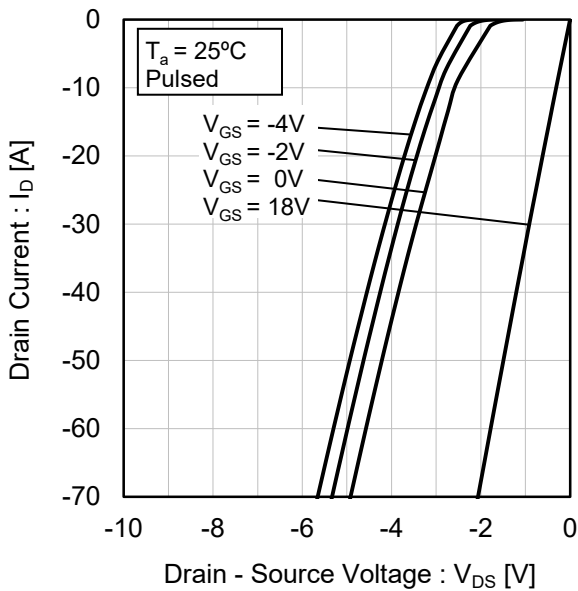

Fig.6 $T_j = 25^\circ\text{C}$ 3rd Quadrant Characteristics



●Electrical characteristic curves

Fig.7 $T_j = 150^\circ\text{C}$ Typical Output Characteristics(I)

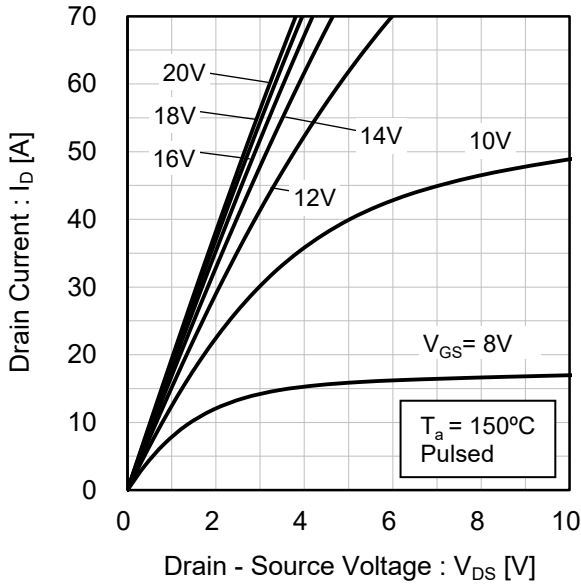

Fig.8 $T_j = 150^\circ\text{C}$ Typical Output Characteristics(II)

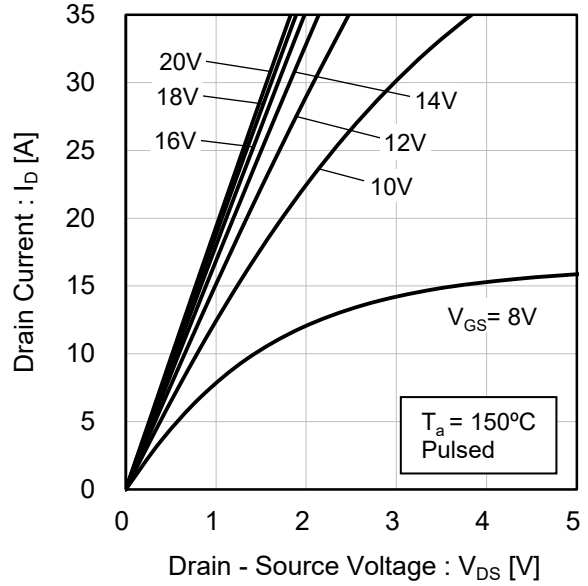

Fig.9 $T_j = 150^\circ\text{C}$ 3rd Quadrant Characteristics

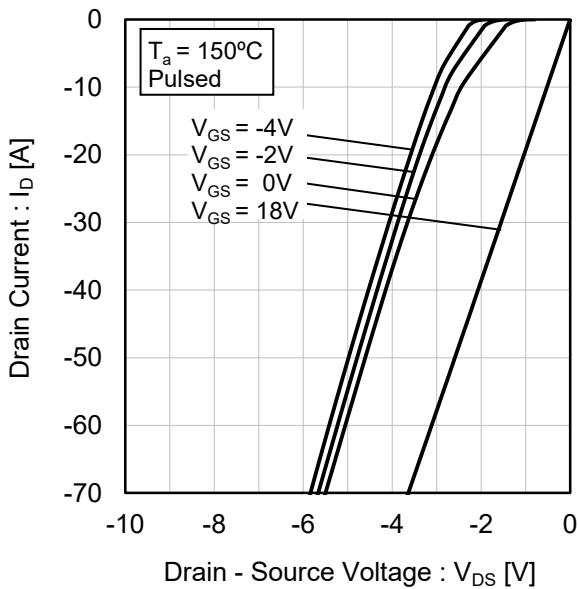
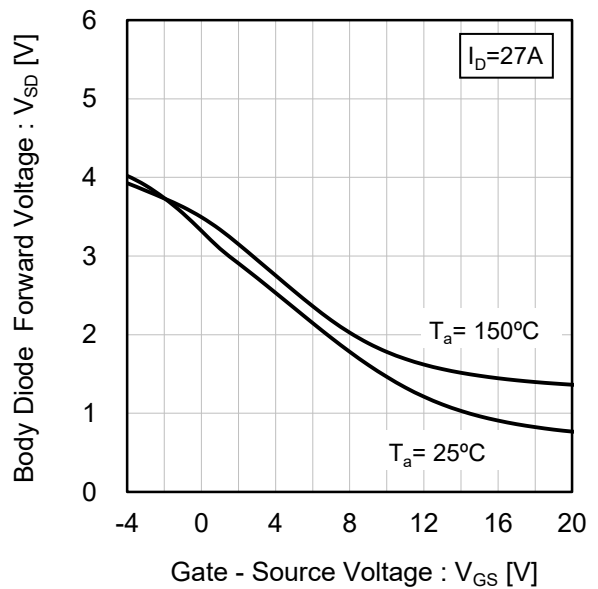

Fig.10 Body Diode Forward Voltage vs. Gate - Source Voltage



●Electrical characteristic curves

Fig.11 Typical Transfer Characteristics (I)

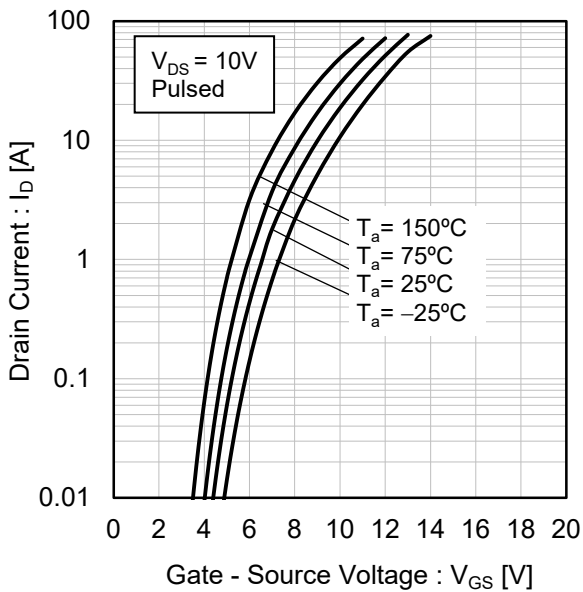

Fig.12 Typical Transfer Characteristics (II)

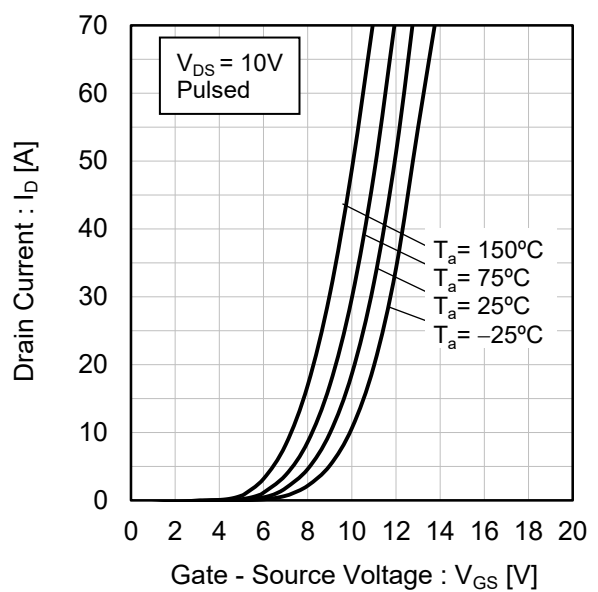

Fig.13 Gate Threshold Voltage vs. Junction Temperature

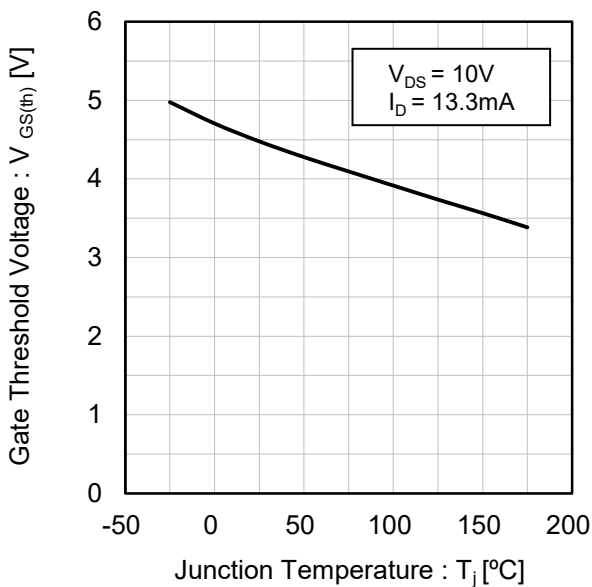
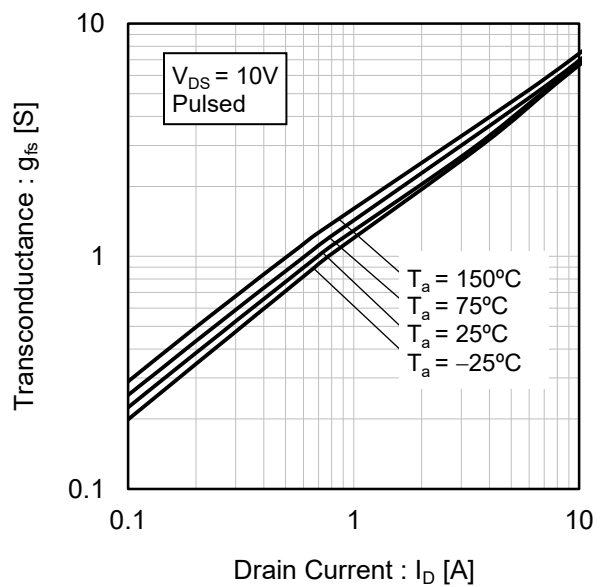

Fig.14 Transconductance vs. Drain Current



●Electrical characteristic curves

Fig.15 Static Drain - Source On - State Resistance vs. Gate - Source Voltage

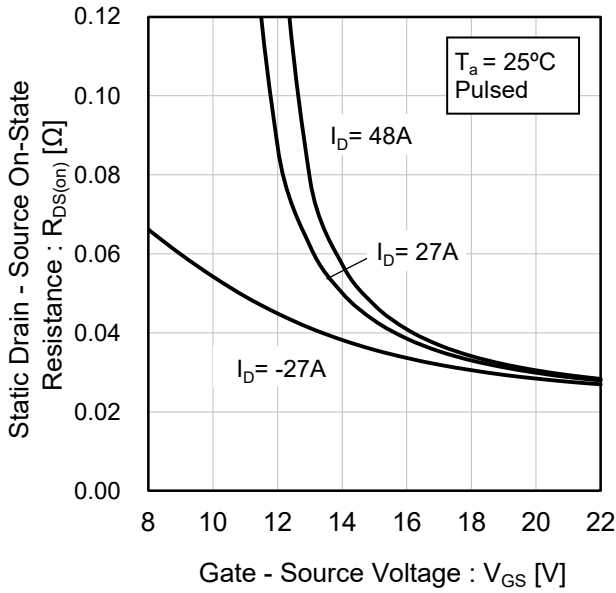

Fig.16 Static Drain - Source On - State Resistance vs. Junction Temperature

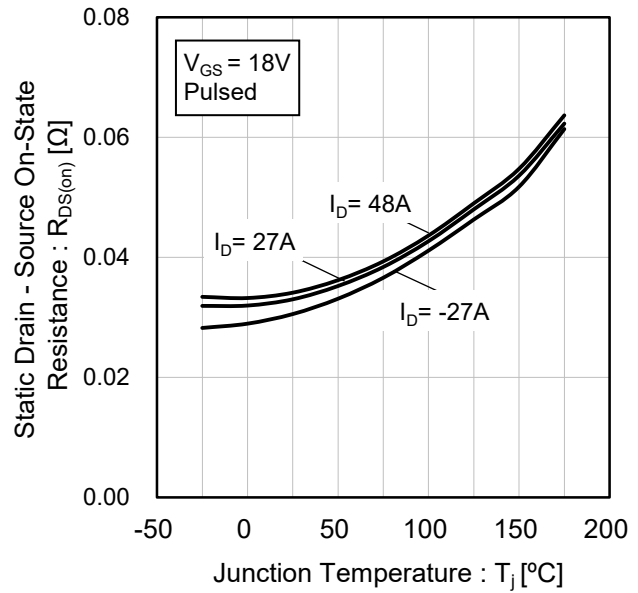

Fig.17 Static Drain - Source On - State Resistance vs. Drain Current

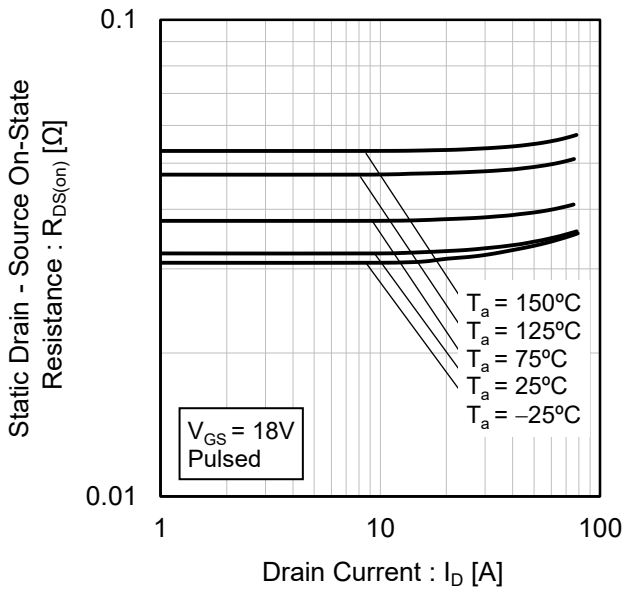
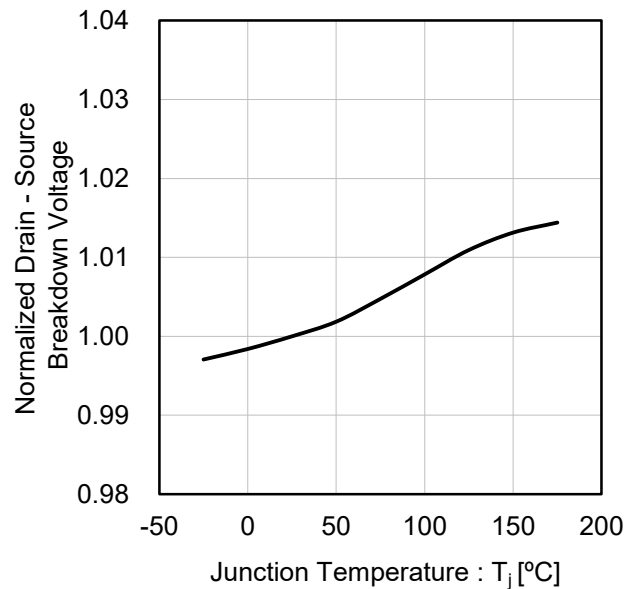

Fig.18 Normalized Drain - Source Breakdown Voltage vs. Junction Temperature



●Electrical characteristic curves

Fig.19 Typical Capacitance vs. Drain - Source Voltage

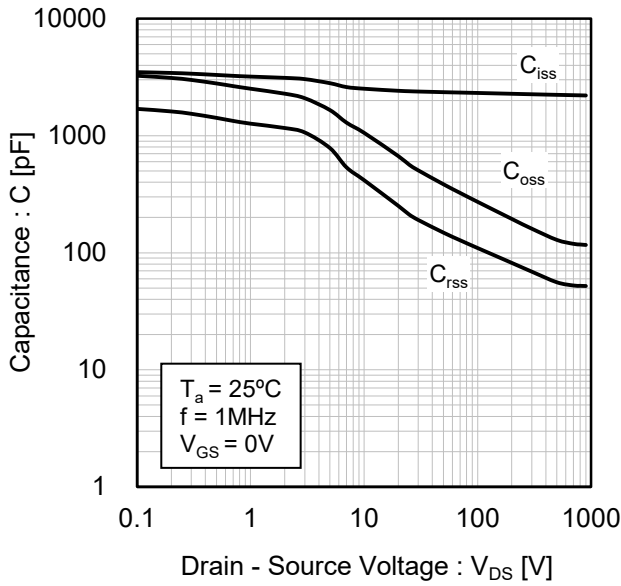

Fig.20 C_{oss} Stored Energy

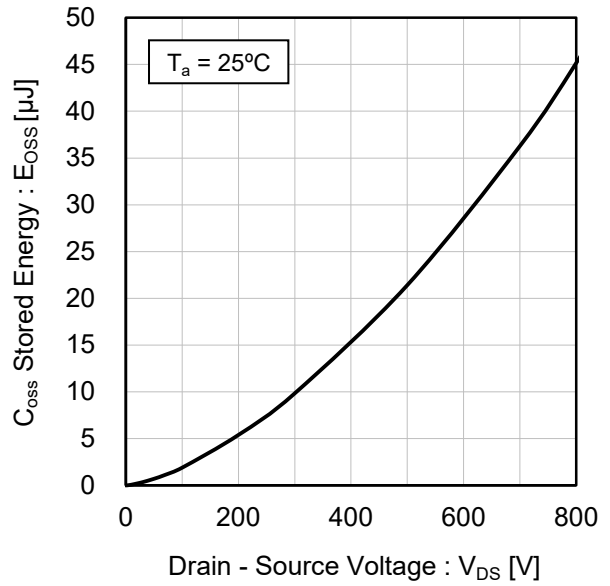
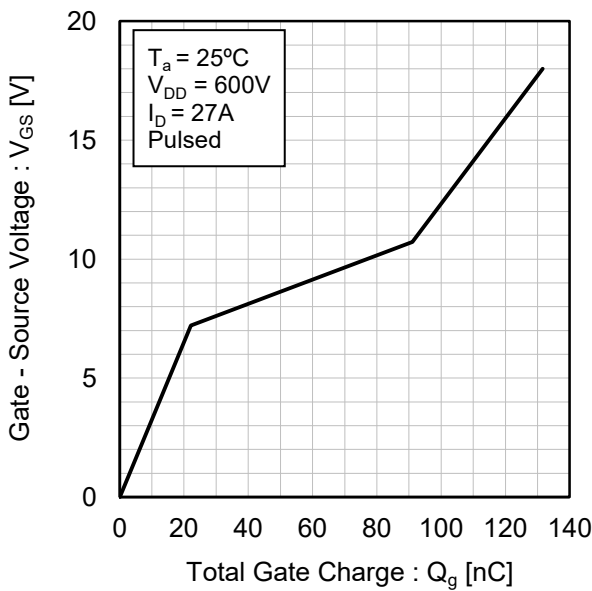
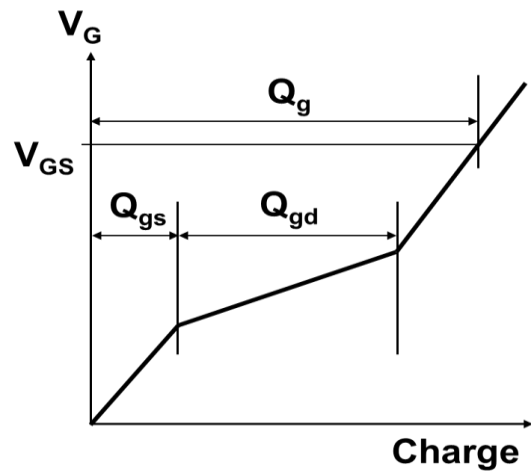

Fig.21 Dynamic Input Characteristics



*Gate Charge Waveform



●Electrical characteristic curves

Fig.19 Typical Switching Time vs. Drain Current

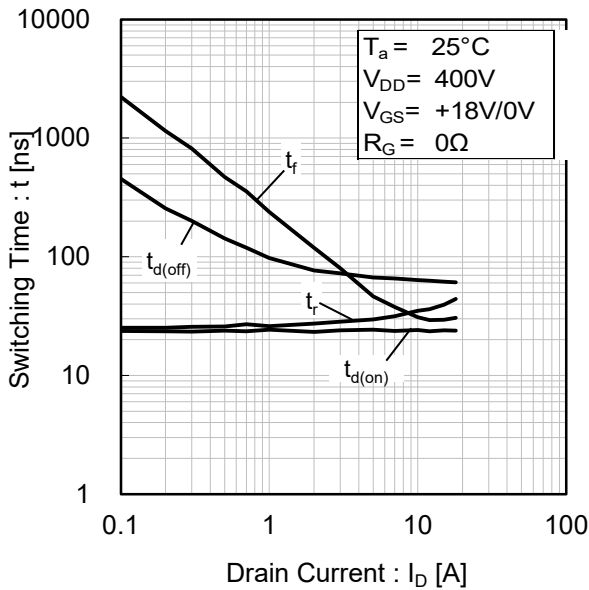

Fig.20 Typical Switching Loss vs. Drain - Source Voltage

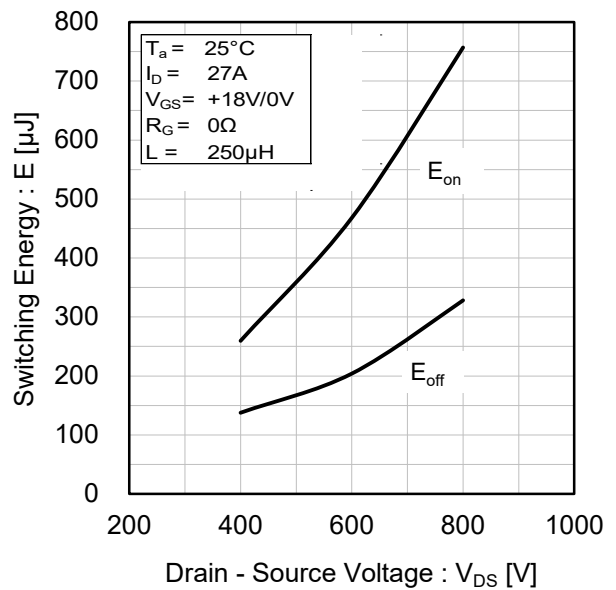

Fig.21 Typical Switching Loss vs. Drain Current

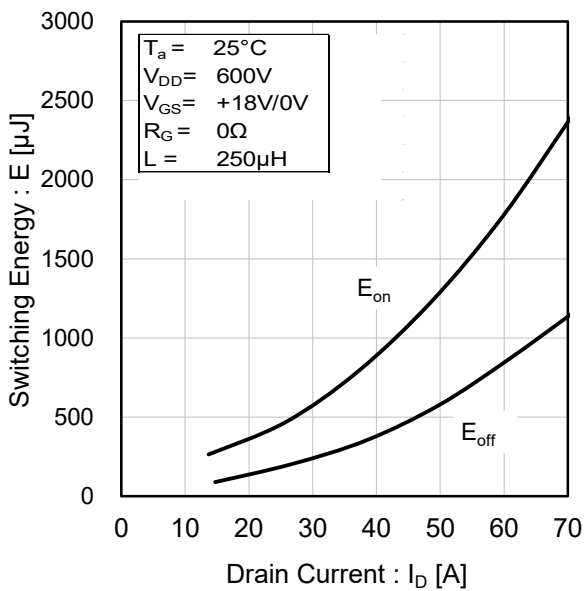
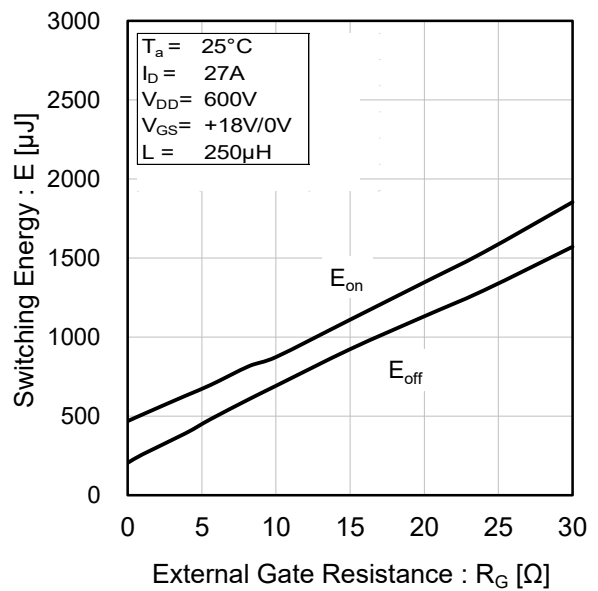

Fig.22 Typical Switching Loss vs. External Gate Resistance



● Measurement circuits and waveforms

Fig.1-1 Gate Charge and Switching Time Measurement Circuit

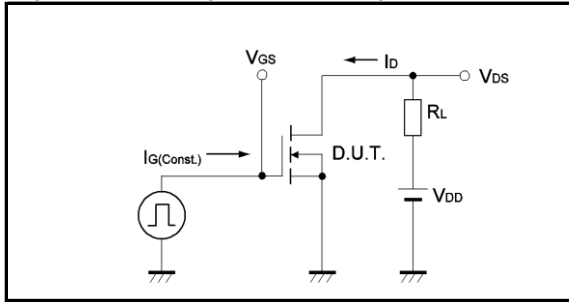

Fig.1-2 Waveforms for Switching Time

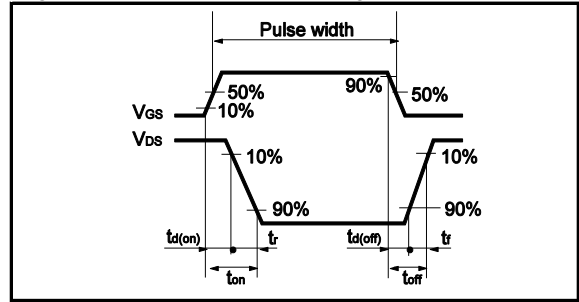

Fig.2-1 Switching Energy Measurement Circuit

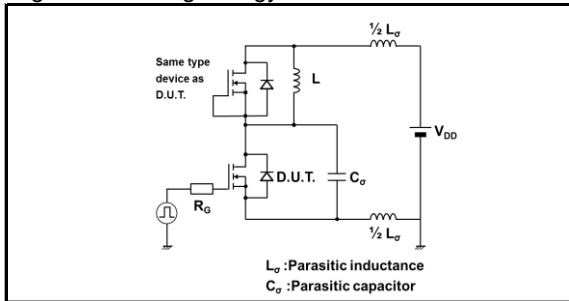

Fig.2-2 Waveforms for Switching Energy Loss

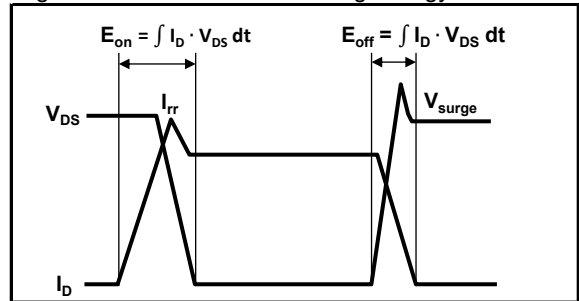

Fig.3-1 Reverse Recovery Time Measurement Circuit

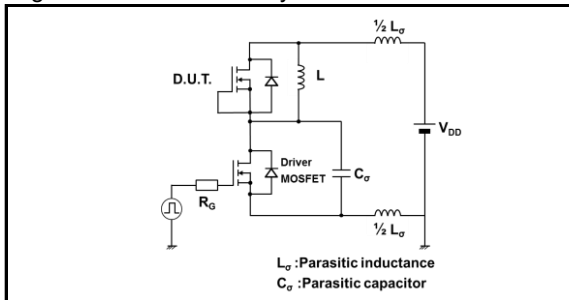
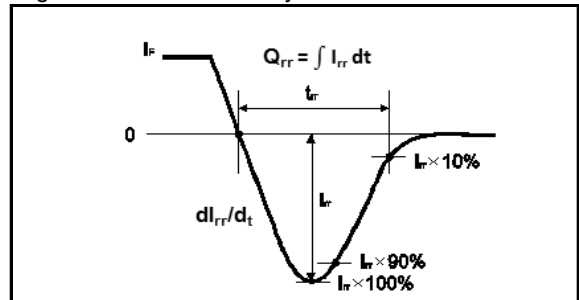

Fig.3-2 Reverse Recovery Waveform



Notes

- 1) The information contained herein is subject to change without notice.
- 2) Before you use our Products, please contact our sales representative and verify the latest specifications.
- 3) Although ROHM is continuously working to improve product reliability and quality, semiconductors can break down and malfunction due to various factors. Therefore, in order to prevent personal injury or fire arising from failure, please take safety measures such as complying with the derating characteristics, implementing redundant and fire prevention designs, and utilizing backups and fail-safe procedures. ROHM shall have no responsibility for any damages arising out of the use of our Products beyond the rating specified by ROHM.
- 4) Examples of application circuits, circuit constants and any other information contained herein are provided only to illustrate the standard usage and operations of the Products. The peripheral conditions must be taken into account when designing circuits for mass production.
- 5) The technical information specified herein is intended only to show the typical functions of and examples of application circuits for the Products. ROHM does not grant you, explicitly or implicitly, any license to use or exercise intellectual property or other rights held by ROHM or any other parties. ROHM shall have no responsibility whatsoever for any dispute arising out of the use of such technical information.
- 6) The Products specified in this document are not designed to be radiation tolerant.
- 7) For use of our Products in applications requiring a high degree of reliability (as exemplified below), please contact and consult with a ROHM representative : transportation equipment (i.e. cars, ships, trains), primary communication equipment, traffic lights, fire/crime prevention, safety equipment, medical systems, and power transmission systems.
- 8) Do not use our Products in applications requiring extremely high reliability, such as aerospace equipment, nuclear power control systems, and submarine repeaters.
- 9) ROHM shall have no responsibility for any damages or injury arising from non-compliance with the recommended usage conditions and specifications contained herein.
- 10) ROHM has used reasonable care to ensure the accuracy of the information contained in this document. However, ROHM does not warrants that such information is error-free, and ROHM shall have no responsibility for any damages arising from any inaccuracy or misprint of such information.
- 11) Please use the Products in accordance with any applicable environmental laws and regulations, such as the RoHS Directive. For more details, including RoHS compatibility, please contact a ROHM sales office. ROHM shall have no responsibility for any damages or losses resulting non-compliance with any applicable laws or regulations.
- 12) When providing our Products and technologies contained in this document to other countries, you must abide by the procedures and provisions stipulated in all applicable export laws and regulations, including without limitation the US Export Administration Regulations and the Foreign Exchange and Foreign Trade Act.
- 13) This document, in part or in whole, may not be reprinted or reproduced without prior consent of ROHM.



Thank you for your accessing to ROHM product informations.
More detail product informations and catalogs are available, please contact us.

ROHM Customer Support System

<http://www.rohm.com/contact/>