

LSIC1MO170T0750
1700 V, 750 mOhm N-Channel SiC MOSFET

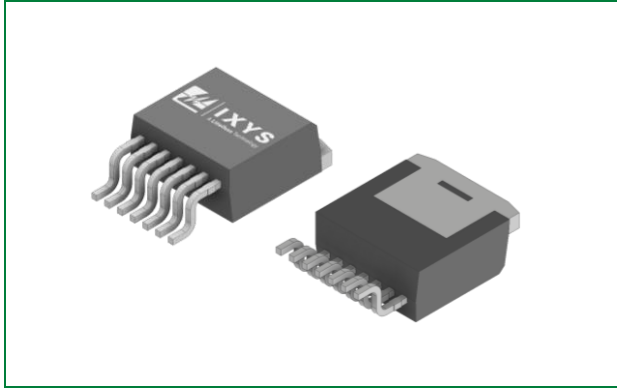

Agency Approvals and Environmental

Environmental Approvals

RoHS **REACH** **HF**

Pinout Diagram

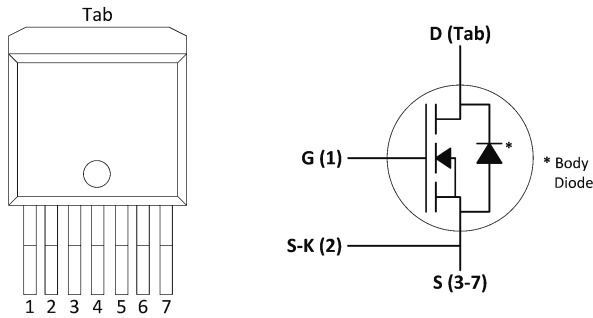

Product Summary

Characteristic	Value	Unit
V_{DS}	1700	V
Typical $R_{DS(ON)}$	750	mOhm
I_D ($T_C \leq 100\text{ }^\circ\text{C}$)	4.5	A

Features

- Optimized for high-frequency, high-efficiency applications
- Extremely low gate charge and output capacitance
- Low gate resistance for high-frequency switching
- Normally-off operations at all temperatures
- Ultra-low on-resistance
- Optimized package with separate driver source pin
- MSL 1 Rated

Applications

- High-frequency applications
- Solar Inverters
- Switch Mode Power Supplies
- UPS
- Motor Drives
- High Voltage DC/DC Converters
- Battery Chargers
- Induction Heating

1. Maximum Ratings 3

2. Thermal Characteristics 3

3. Electrical Characteristics 3

 3.1. Static Characteristics ($T_J = 25\text{ }^\circ\text{C}$ unless otherwise specified) 3

 3.2. Dynamic Characteristics ($T_J = 25\text{ }^\circ\text{C}$ unless otherwise specified) 4

4. Reverse Diode Characteristics 4

5. Figure Data 5

6. Package Dimensions 9

7. Part Numbering and Marking 9

8. Packing Options 9

9. Packing Specifications 10

1. Maximum Ratings

Characteristic	Symbol	Conditions	Value	Unit
Drain-Source Voltage	V_{DS}	$V_{GS} = 0\text{ V}$	1700	V
Continuous Drain Current	I_D	$V_{GS} = 20\text{ V}, T_C = 25\text{ }^\circ\text{C}$	6.4	A
		$V_{GS} = 20\text{ V}, T_C = 100\text{ }^\circ\text{C}$	4.5	
Pulsed Drain Current ¹	$I_{D(pulse)}$	$T_C = 25\text{ }^\circ\text{C}$	11	A
Power Dissipation	P_D	$T_C = 25\text{ }^\circ\text{C}, T_J = 175\text{ }^\circ\text{C}$	65	W
Gate-Source Voltage	$V_{GS,MAX}$	Absolute maximum values – Steady state	-6 to +22	V
	$V_{GS,OP,TR}$ ²	Transient, $t_{transient} < 300\text{ nsec}$	-10 to +25	
	$V_{GS,OP}$ ³	Recommended DC operating values	-5 to +20	
Operating Junction Temperature	T_J	-	-55 to +175	$^\circ\text{C}$
Storage Temperature	T_{STG}	-	-55 to +150	$^\circ\text{C}$
Lead Temperature for Soldering (MSL 1 Rated)	T_{SOLD}	-	260	$^\circ\text{C}$

Footnote 1: Pulse width limited by $T_{J,MAX}$

Footnote 2: See Figure 21 for further information

Footnote 3: MOSFET can operate with $V_{GS(OFF)} = 0\text{ V}$ – dependent upon PCB layout. $V_{GS(OFF)} = -5\text{ V}$ provides added noise margin and faster turn-off speed

2. Thermal Characteristics

Characteristic	Symbol	Value	Unit
Maximum Thermal Resistance, junction-to-case	$R_{th,JC,MAX}$	2.3	$^\circ\text{C/W}$
Maximum Thermal Resistance, junction-to-ambient	$R_{th,JA,MAX}$	40	$^\circ\text{C/W}$

3. Electrical Characteristics

3.1. Static Characteristics ($T_J = 25\text{ }^\circ\text{C}$ unless otherwise specified)

Characteristic	Symbol	Conditions	Value			Unit
			Min	Typ	Max	
Drain-Source Breakdown Voltage	$V_{(BR)DSS}$	$V_{GS} = 0\text{ V}, I_D = 100\text{ }\mu\text{A}$	1700	-	-	V
Zero Gate Voltage Drain Current	I_{DSS}	$V_{DS} = 1700\text{ V}, V_{GS} = 0\text{ V}$	-	0.05	10	μA
		$V_{DS} = 1700\text{ V}, V_{GS} = 0\text{ V}, T_J = 175\text{ }^\circ\text{C}$	-	0.1	-	
Gate Leakage Current	$I_{GSS,F}$	$V_{GS} = 22\text{ V}, V_{DS} = 0\text{ V}$	-	-	100	nA
	$I_{GSS,R}$	$V_{GS} = -6\text{ V}, V_{DS} = 0\text{ V}$	-	-	100	
Drain-Source On-State Resistance	$R_{DS(ON)}$	$I_D = 2\text{ A}, V_{GS} = 20\text{ V}$	-	750	1000	m Ω
		$I_D = 2\text{ A}, V_{GS} = 20\text{ V}, T_J = 175\text{ }^\circ\text{C}$	-	1550	-	
Gate Threshold Voltage	$V_{GS(TH)}$	$V_{DS} = V_{GS}, I_D = 1\text{ mA}$	1.8	2.8	4.0	V
		$V_{DS} = V_{GS}, I_D = 1\text{ mA}, T_J = 175\text{ }^\circ\text{C}$	-	1.9	-	
Gate Resistance	R_G	Resonance method, Drain-Source shorted ¹	-	29	-	Ω

Footnote 1: For a description of the resonance method for measuring R_G , refer to the JEDEC Standard JESD24-11 test method

3.2. Dynamic Characteristics ($T_J = 25\text{ }^\circ\text{C}$ unless otherwise specified)

Characteristic	Symbol	Conditions	Value			Unit
			Min	Typ	Max	
Turn-On Switching Energy	E_{ON}	$V_{DD} = 1200\text{ V}$, $I_D = 2\text{ A}$, $V_{GS} = -5 / +20\text{ V}$, $R_{G,ext} = 2\ \Omega$, $L = 1.4\text{ mH}$, FWD = LSIC1MO170T0750	-	80	-	mJ
Turn-Off Switching Energy	E_{OFF}		-	43	-	
Total Per-Cycle Switching Energy	E_{TS}		-	123	-	
Input Capacitance	C_{ISS}	$V_{DD} = 1000\text{ V}$, $V_{GS} = 0\text{ V}$, $f = 1\text{ MHz}$, $V_{AC} = 25\text{ mV}$	-	200	-	pF
Output Capacitance	C_{OSS}		-	11.5	-	
Reverse Transfer Capacitance	C_{RSS}		-	1.7	-	
COSS Stored Energy	E_{OSS}		-	5.7	-	
Total Gate Charge	Q_g	$V_{DD} = 1200\text{ V}$, $I_D = 2\text{ A}$, $V_{GS} = -5 / +20\text{ V}$	-	11	-	nC
Gate-Source Charge	Q_{gs}		-	4	-	
Gate-Drain Charge	Q_{gd}		-	5	-	
Turn-On Delay Time	$t_{d(on)}$	$V_{DD} = 1200\text{ V}$, $V_{GS} = -5 / +20\text{ V}$, $I_D = 2\text{ A}$, $R_{G,ext} = 2\ \Omega$, $R_L = 600\ \Omega$, Timing relative to V_{DS}	-	8	-	ns
Rise Time	t_r		-	15	-	
Turn-Off Delay Time	$t_{d(off)}$		-	27	-	
Fall Time	t_f		-	173	-	

4. Reverse Diode Characteristics

Characteristic	Symbol	Conditions	Value			Unit
			Min	Typ	Max	
Diode Forward Voltage	V_{SD}	$I_S = 1\text{ A}$, $V_{GS} = 0\text{ V}$	-	3.6	-	V
		$I_S = 1\text{ A}$, $V_{GS} = 0\text{ V}$, $T_J = 175\text{ }^\circ\text{C}$	-	3.2	-	
Continuous Diode Forward Current	I_S	$V_{GS} = 0\text{ V}$, $T_C = 25\text{ }^\circ\text{C}$	-	-	10	A
Peak Diode Forward Current ¹	I_{SP}		-	-	15	

Footnote 1: Pulse width limited by $T_{J,MAX}$

5. Figure Data

Figure 1. Maximum Power Dissipation ($T_J = 175\text{ }^\circ\text{C}$)

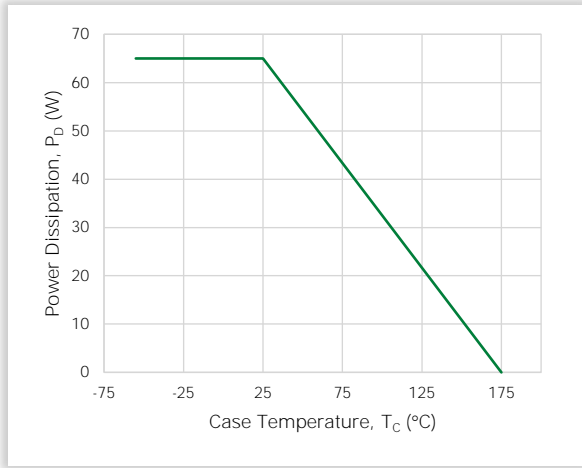

Figure 2. Typical Transfer Characteristics

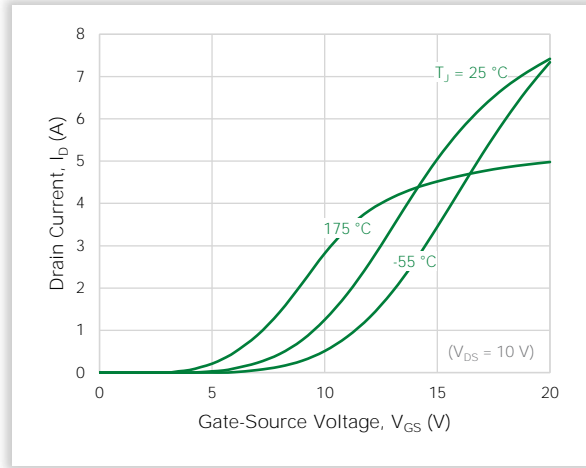

Figure 3. Typical Output Characteristics ($T_J = 25\text{ }^\circ\text{C}$)

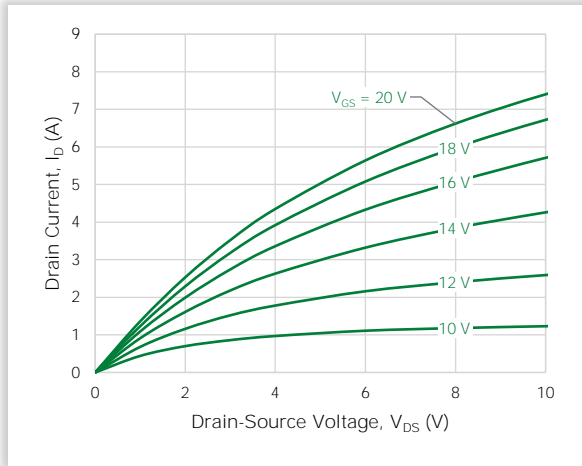

Figure 4. Typical Output Characteristics ($T_J = 175\text{ }^\circ\text{C}$)

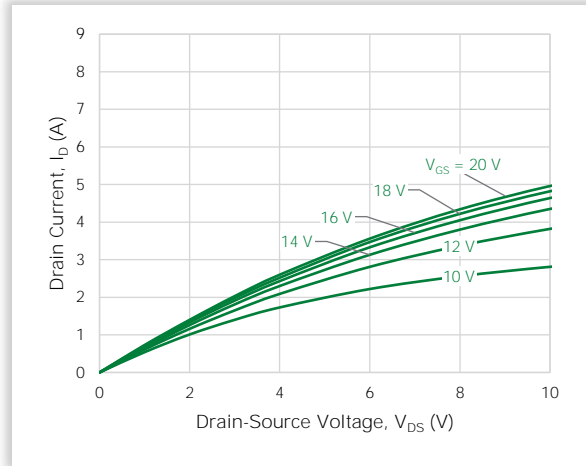

Figure 5. Typical Output Characteristics ($T_J = -55\text{ }^\circ\text{C}$)

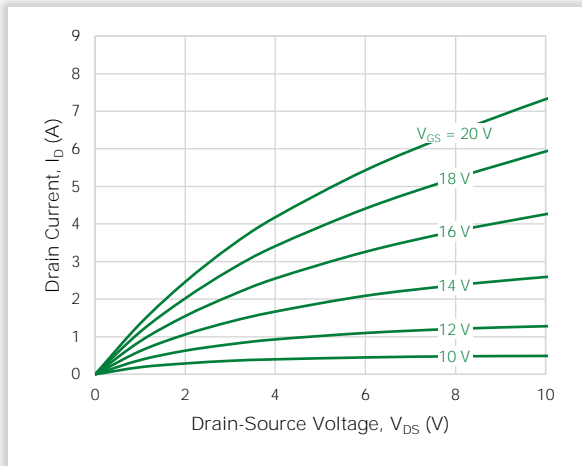

Figure 6. Typical Reverse Conduction Characteristics ($T_J = 25\text{ }^\circ\text{C}$)

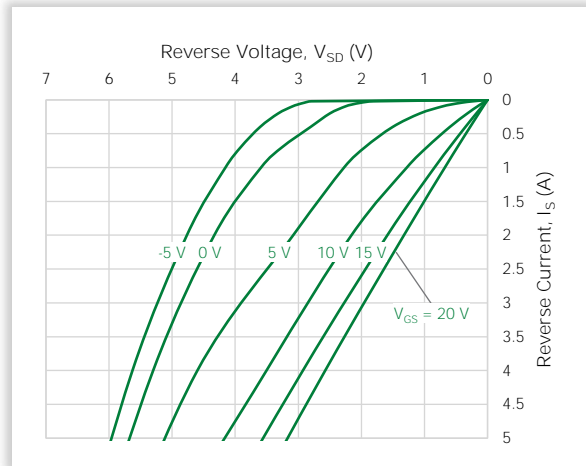

Figure 7. Typical Reverse Conduction Characteristics ($T_J = 175\text{ }^\circ\text{C}$)

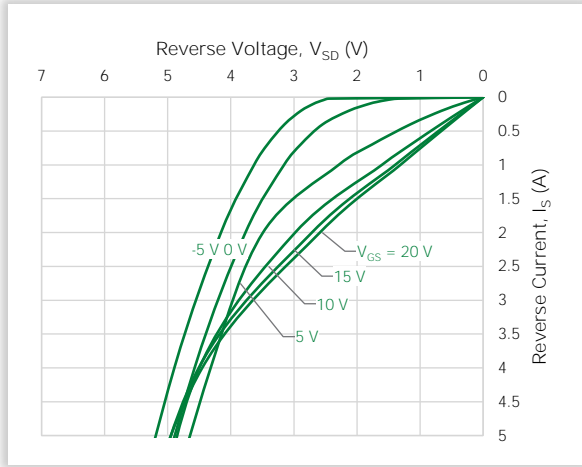

Figure 8. Typical Reverse Conduction Characteristics ($T_J = -55\text{ }^\circ\text{C}$)

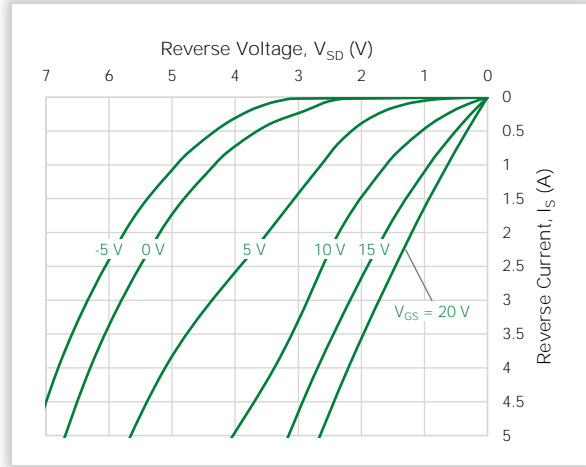

Figure 9. Normalized Transient Thermal Impedance

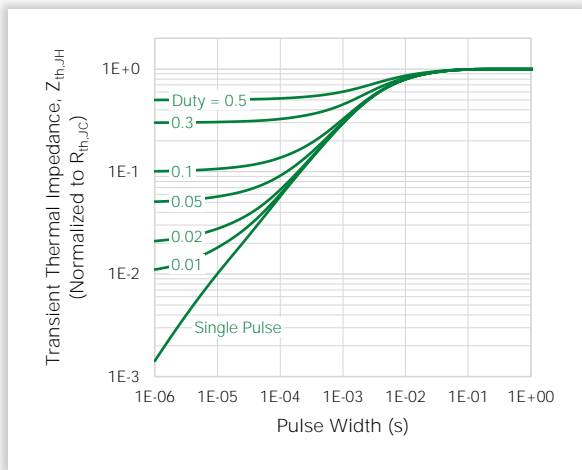

Figure 10. Maximum Safe Operating Area ($T_C = 25\text{ }^\circ\text{C}$)

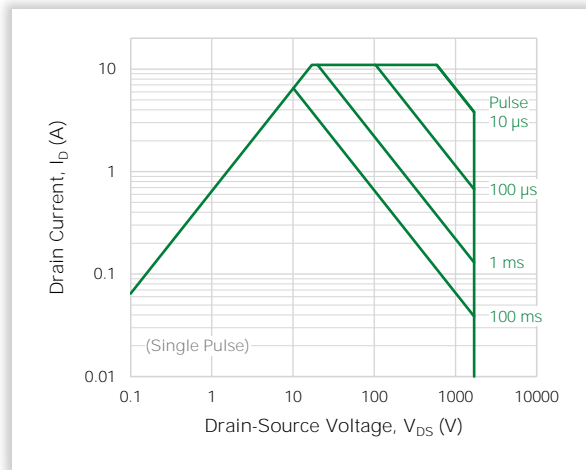

Figure 11. Typical On-resistance vs. Drain Current

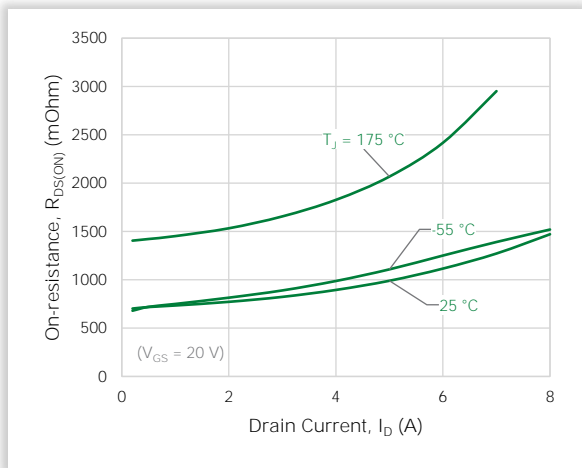

Figure 12. Normalized On-resistance vs. Junction Temperature

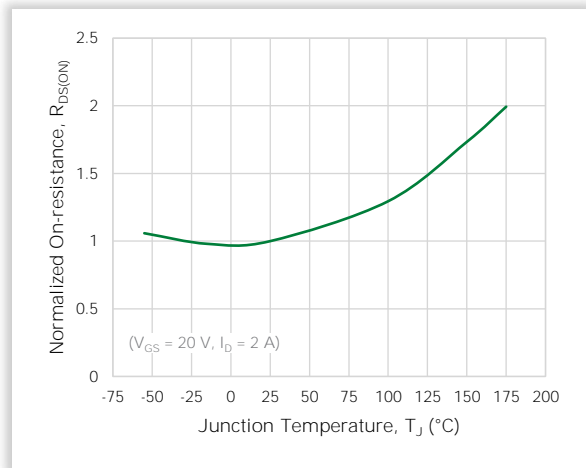

Figure 13. Typical On-resistance vs. Junction Temperature

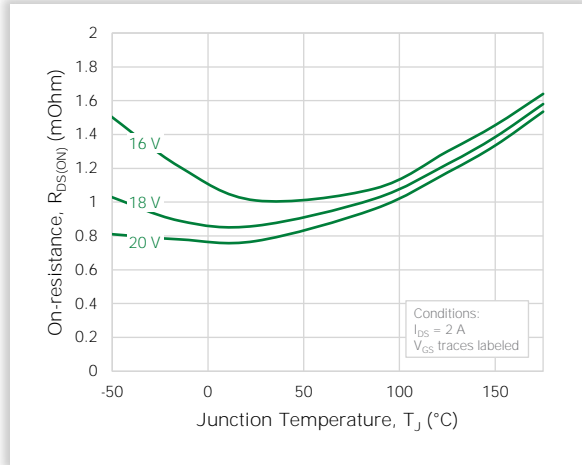

Figure 14. Typical Threshold Voltage

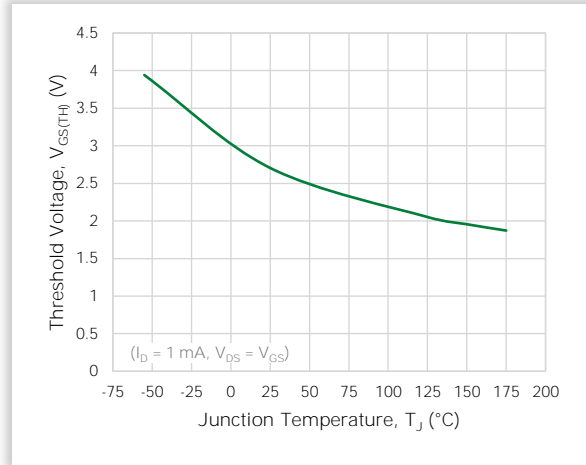

Figure 15. Typical Junction Capacitances up to 1000 V

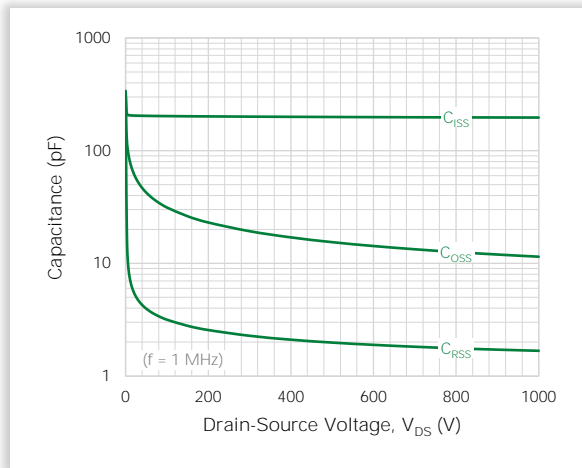

Figure 16. Typical Junction Capacitances up to 200 V

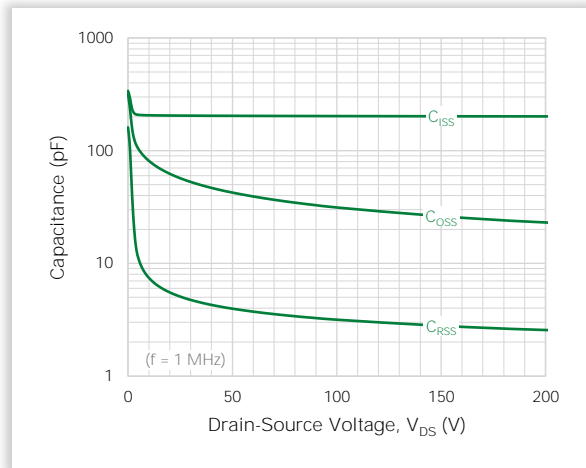

Figure 17. Typical C_{oss} Stored Energy E_{oss}

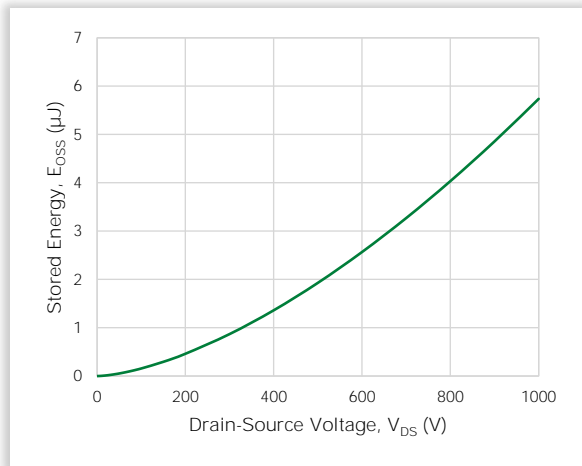

Figure 18. Typical Gate Charge

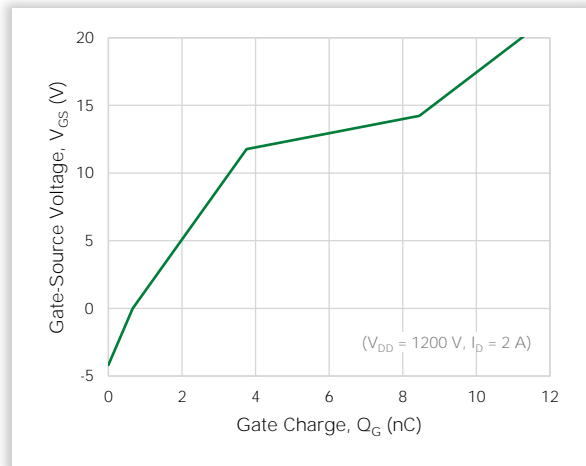

Figure 19. Typical Switching Energy vs. Drain Current

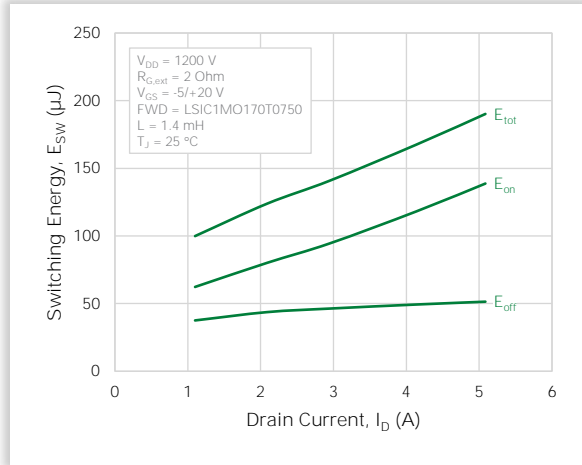

Figure 20. Typical Switching Energy vs. External Gate Resistance

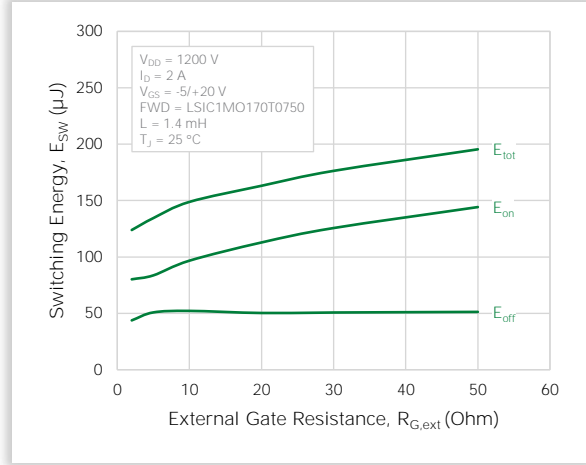
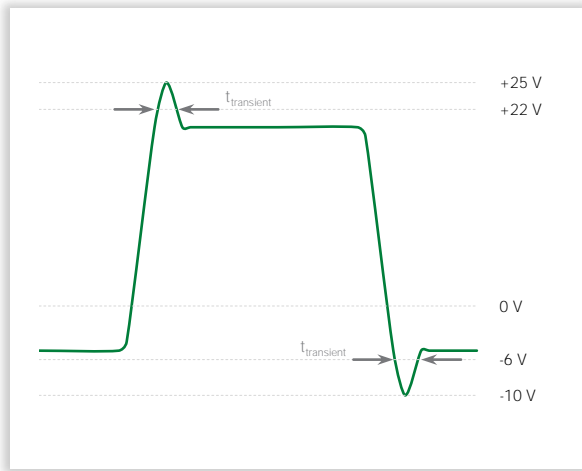
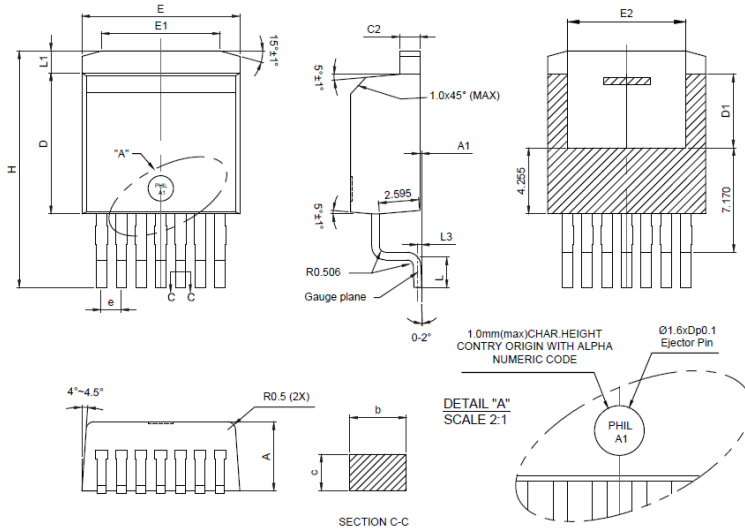

Figure 21. V_{GS} Waveform Definitions



6. Package Dimensions



Symbol	Millimeters		
	Min	Nom	Max
A	4.300	4.435	4.570
A1	0.000	0.125	0.250
b	0.500	0.600	0.700
c	0.330	0.490	0.650
C2	1.170	1.285	1.400
D	9.025	9.075	9.125
D1	4.656	4.733	4.810
E	10.130	10.180	10.230
E1	6.500	7.550	8.600
E2	6.778	7.223	7.665
e	1.220	1.270	1.320
H	15.043	16.178	17.121
L	2.324	2.512	2.700
L1	1.160	1.418	1.676
L3		0.254	

Recommended Solder Pad Layout:

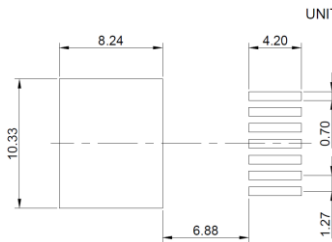

Notes:

- UNIT: mm
- Dimensions D & E do not include mold flash. Mold flash shall not exceed 0.127 mm per side. These dimensions are measured at the outermost extreme of the plastic body.
 - Package is designed for high voltage and does not conform to JEDEC std.
 - Top package/marketing surface finish: 16-18 VDI.

7. Part Numbering and Marking

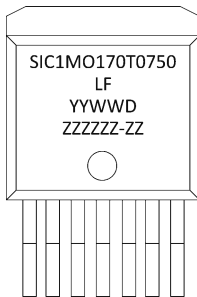

- SiC = SiC
- 1 = Gen 1
- MO = MOSFET
- 170 = Voltage Rating (1700 V)
- T = TO-263-7L
- 0750 = R_{DS(ON)} (750 mOhm)
- YY = Year
- WW = Week
- D = Special Code
- ZZZZZZ-ZZ = Lot Number

8. Packing Options

Part Number	Marking	Packing Mode	M.O.Q.
LSIC1MO170T0750	SIC1MO170T0750	Tube (50 Pcs)	400

9. Packing Specifications

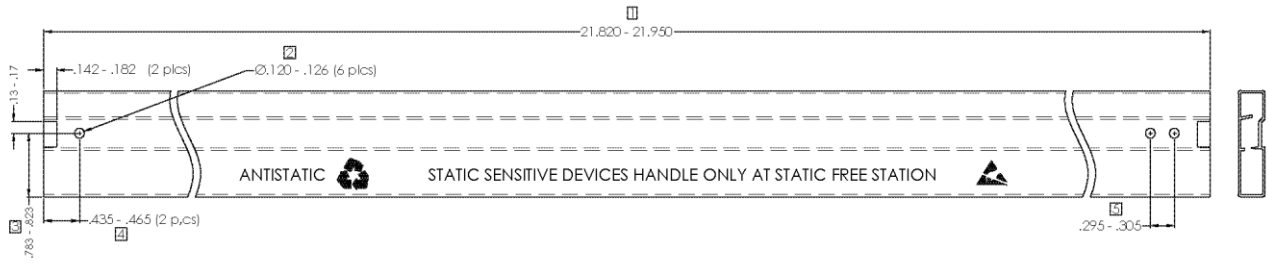

Notes:

- 1. Clear PVC material with anti-static coating
- 2. Radius is a maximum of 0.5 unless otherwise specified
- 3. Critical areas are labeled in box
- 4. All pin plug holes are considered critical dimension
- 5. Material thickness is 0.75 ±0.10
- 6. Tolerance unless otherwise specified is : Decimal ±0.05 Angle ±1°
- 7. Dimensions are in inches

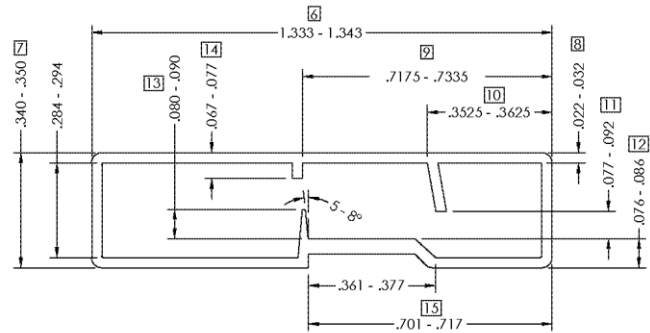

For additional information please visit www.Littelfuse.com/powersemi

Disclaimer Notice - Littelfuse products are not designed for, and shall not be used for, any purpose (including, without limitation, automotive, military, aerospace, medical, life-saving, life-sustaining or nuclear facility applications, devices intended for surgical implant into the body, or any other application in which the failure or lack of desired operation of the product may result in personal injury, death, or property damage) other than those expressly forth in applicable Littelfuse product documentation. Littelfuse shall not be liable for any claims or damages arising out of products used in applications not expressly intended by Littelfuse as set forth in applicable Littelfuse documentation.

Read complete Disclaimer Notice at www.littelfuse.com/disclaimer-electronics