

C4D30120H

4th Generation 1200 V, 30 A Silicon Carbide Schottky Diode

Description

With the performance advantages of a Silicon Carbide (SiC) Schottky Barrier diode, power electronics systems can expect to meet higher efficiency standards than Si-based solutions, while also reaching higher frequencies and power densities. SiC diodes can be easily paralleled to meet various application demands, without concern of thermal runaway. In combination with the reduced cooling requirements and improved thermal performance of SiC products, SiC diodes are able to provide lower overall system costs in a variety of diverse applications.

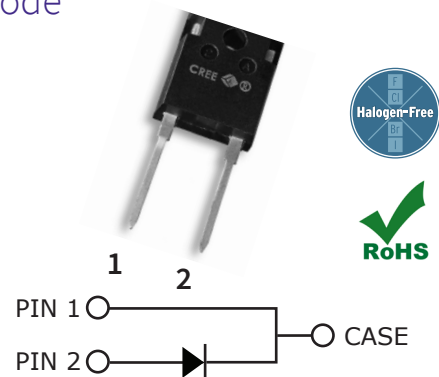

Package Type: TO-247-2
Marking: C4D30120

Features

- Low Forward Voltage (V_f) Drop with Positive Temperature Coefficient
- Zero Reverse Recovery Current / Forward Recovery Voltage
- Temperature-Independent Switching Behavior
- Increased Creepage / Clearance + HV-H3TRB Rugged

Applications

- Battery Chargers
- Solar & Renewable Energy Power Conversion
- Industrial Power Supplies
- Boost Diodes in PFC & DC-DC

Maximum Ratings ($T_c = 25^\circ\text{C}$ unless otherwise specified)

Parameter	Symbol	Value	Unit	Test Conditions	Note
Repetitive Peak Reverse Voltage	V_{RRM}	1200	V		
DC Blocking Voltage	V_{DC}	1200			
Continuous Forward Current	I_F	94	A	$T_J = 25^\circ\text{C}$	Fig. 3
		45		$T_J = 135^\circ\text{C}$	
		30		$T_J = 155^\circ\text{C}$	
Repetitive Peak Forward Surge Current	I_{FRM}	121	A	$T_c = 25^\circ\text{C}, t_p = 10\text{ ms}, \text{Half Sine Pulse}$	
		68		$T_c = 110^\circ\text{C}, t_p = 10\text{ ms}, \text{Half Sine Pulse}$	
Non-Repetitive Forward Surge Current	I_{FSM}	233	A	$T_c = 25^\circ\text{C}, t_p = 10\text{ ms}, \text{Half Sine Pulse}$	
		209		$T_c = 110^\circ\text{C}, t_p = 10\text{ ms}, \text{Half Sine Pulse}$	
Power Dissipation	P_{tot}	441	W	$T_J = 25^\circ\text{C}$	Fig. 4
		191		$T_J = 110^\circ\text{C}$	
i^2t Value	$\int i^2t$	271	A^2s	$T_c = 25^\circ\text{C}, t_p = 10\text{ ms}$	
		218		$T_c = 110^\circ\text{C}, t_p = 10\text{ ms}$	



Electrical Characteristics

Parameter	Symbol	Typ.	Max.	Units	Test Conditions	Note
Forward Voltage	V_F	1.5	1.8	V	$I_F = 30 \text{ A}, T_J = 25 \text{ }^\circ\text{C}$	Fig. 1
		2.2	3		$I_F = 30 \text{ A}, T_J = 175 \text{ }^\circ\text{C}$	
Reverse Current	I_R	40	250	μA	$V_R = 1200 \text{ V}, T_J = 25 \text{ }^\circ\text{C}$	Fig. 2
		70	450		$V_R = 1200 \text{ V}, T_J = 175 \text{ }^\circ\text{C}$	
Total Capacitive Charge	Q_C	152		nC	$V_R = 800 \text{ V}, T_J = 25 \text{ }^\circ\text{C}$	Fig. 5
Total Capacitance	C	2,177		pF	$V_R = 0 \text{ V}, T_J = 25 \text{ }^\circ\text{C}, f = 1 \text{ MHz}$	Fig. 6
		136			$V_R = 400 \text{ V}, T_J = 25 \text{ }^\circ\text{C}, f = 1 \text{ MHz}$	
		100			$V_R = 800 \text{ V}, T_J = 25 \text{ }^\circ\text{C}, f = 1 \text{ MHz}$	
Capacitance Stored Energy	E_C	44		μJ	$V_R = 800 \text{ V}$	Fig. 7

Note:

SiC Schottky Diodes are majority carrier devices, so there is no reverse recovery charge.

Thermal & Mechanical Characteristics

Parameter	Symbol	Value	Units	Note
Thermal Resistance, Junction to Case (Typ.)	$R_{\theta,JC}$	0.34	$^\circ\text{C} / \text{W}$	
Operating Junction & Storage Temperature	T_J, T_{stg}	-55 to +175	$^\circ\text{C}$	Fig. 8
Maximum Processing Temperature	T_{PROC}	325		10 min. Maximum

Electrostatic Discharge (ESD) Classifications

Parameter	Symbol	Value
Human Body Model	HBM	Class 3B ($\geq 8000 \text{ V}$)
Charge Device Model	CDM	Class C3 ($\geq 1000 \text{ V}$)



Typical Performance

Figure 1. Forward Characteristics

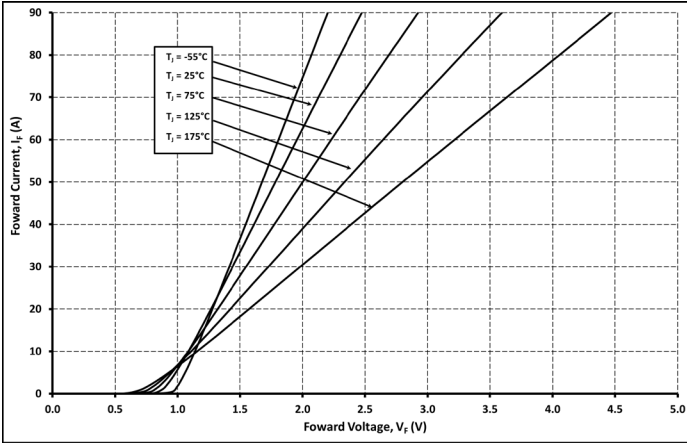

Figure 2. Reverse Characteristics

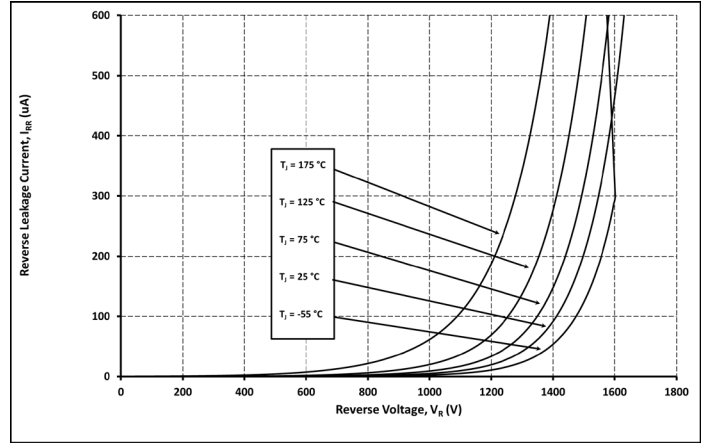

Figure 3. Current Derating

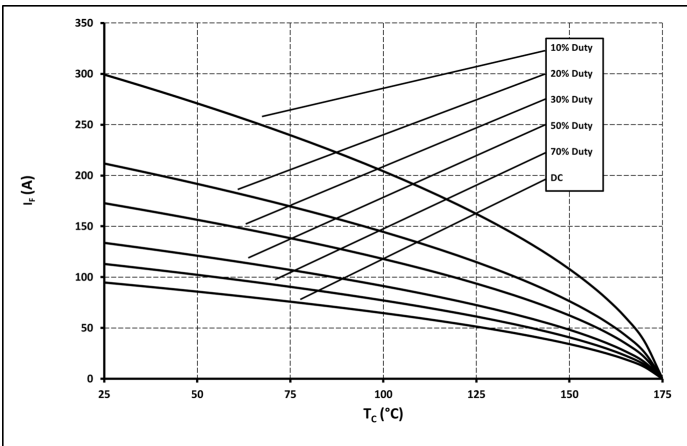

Figure 4. Power Derating

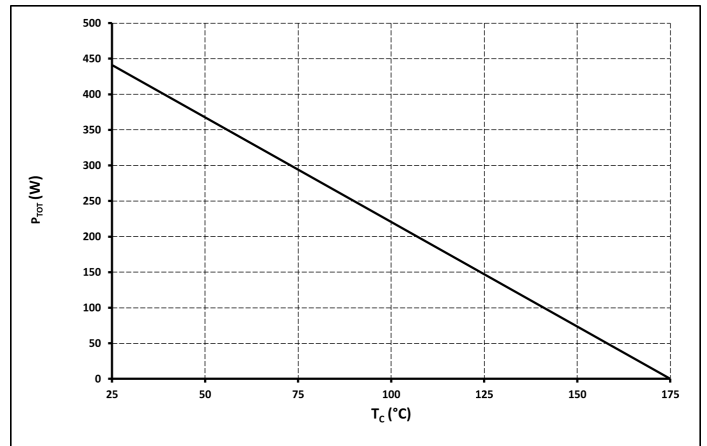

Figure 5. Total Capacitance Charge vs. Reverse Voltage

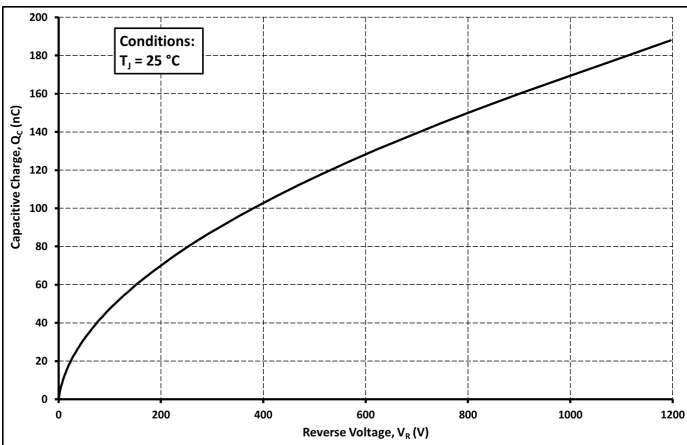
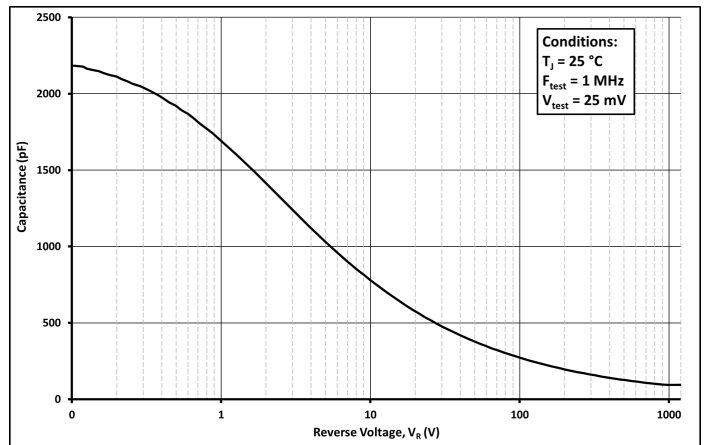

Figure 6. Capacitance vs. Reverse Voltage





Typical Performance

Figure 7. Capacitance Stored Energy

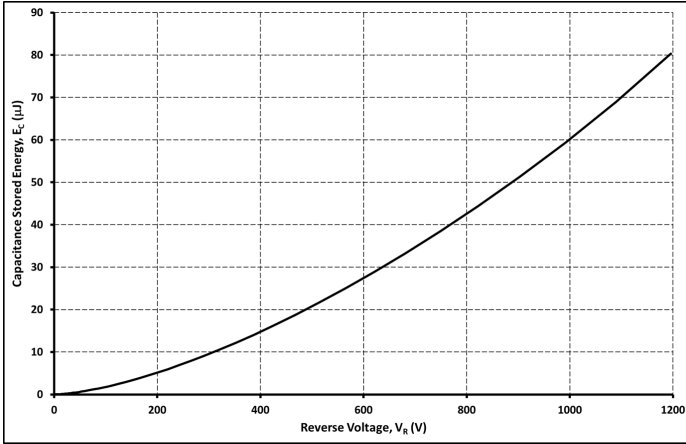
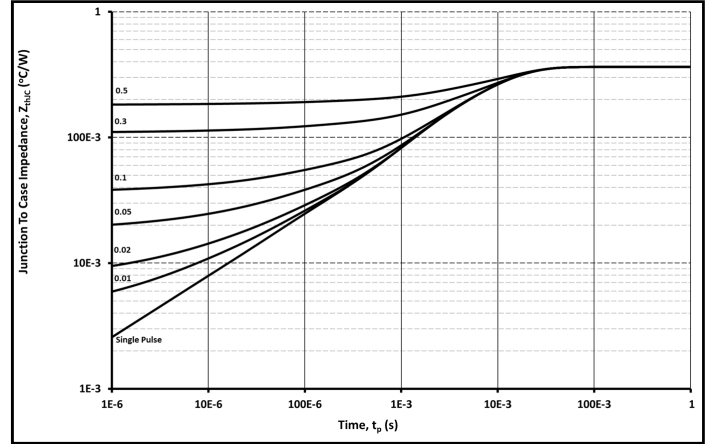

Figure 8. Transient Thermal Impedance





Package Dimensions

Package: TO-247-2

All dimensions in mm.

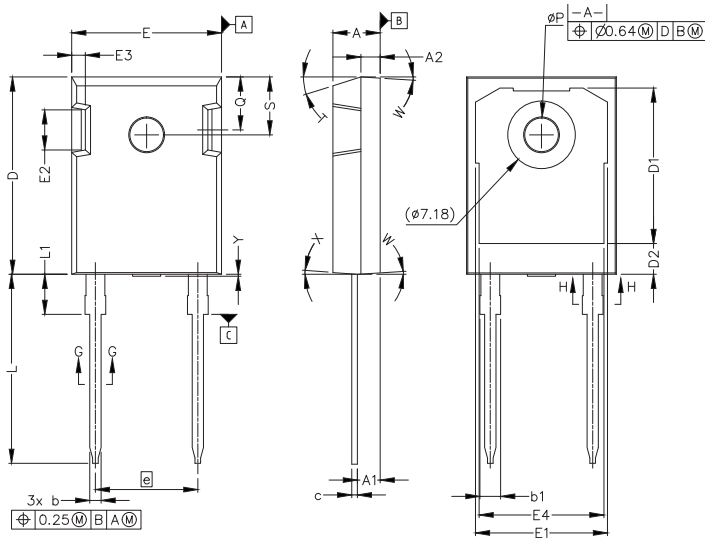

SYM	MILLIMETERS		INCHES	
	MIN	MAX	MIN	MAX
A	4.83	5.21	.190	.205
A1	2.29	2.54	.090	.100
A2	1.91	2.16	.075	.085
b'	1.07	1.28	.042	.050
b	1.07	1.33	.042	.052
b1	1.91	2.41	.075	.095
b2	1.91	2.16	.075	.085
c'	0.55	0.65	.022	.026
c	0.55	0.68	.022	.027
D	20.80	21.10	.819	.831
D1	16.25	17.35	.640	.683
D2	2.86	3.16	.112	.124
E	15.75	16.13	.620	.635
E1	13.10	14.15	.516	.557
E2	3.68	5.10	.145	.201
E3	1.00	1.90	.039	.075
E4	12.38	13.43	.487	.529
e	10.88 BSC		.428 BSC	
L	19.81	20.32	.780	.800
L1	4.10	4.40	.161	.173
øP	3.51	3.65	.138	.144
Q	5.49	6.00	.216	.236
S	6.04	6.30	.238	.248
T	17.5° REF.			
W	3.5° REF.			
X	4° REF.			
Y	0	0.50	0	0.020

Recommended Solder Pad Layout



all units are in inches

Learn more about recommended soldering profiles in [this application note](#).



Notes

This document and the information contained herein are subject to change without notice. Any such change shall be evidenced by the publication of an updated version of this document by Cree. No communication from any employee or agent of Cree or any third party shall effect an amendment or modification of this document. No responsibility is assumed by Cree for any infringement of patents or other rights of third parties which may result from use of the information contained herein. No license is granted by implication or otherwise under any patent or patent rights of Cree.

Notwithstanding any application-specific information, guidance, assistance, or support that Cree may provide, the buyer of this product is solely responsible for determining the suitability of this product for the buyer's purposes, including without limitation for use in the applications identified in the next bullet point, and for the compliance of the buyers' products, including those that incorporate this product, with all applicable legal, regulatory, and safety-related requirements.

This product has not been designed or tested for use in, and is not intended for use in, applications in which failure of the product would reasonably be expected to cause death, personal injury, or property damage, including but not limited to equipment implanted into the human body, life-support machines, cardiac defibrillators, and similar emergency medical equipment, aircraft navigation, communication, and control systems, aircraft power and propulsion systems, air traffic control systems, and equipment used in the planning, construction, maintenance, or operation of nuclear facilities.

RoHS Compliance

The levels of RoHS restricted materials in this product are below the maximum concentration values (also referred to as the threshold limits) permitted for such substances, or are used in an exempted application, in accordance with EU Directive 2011/65/EC (RoHS2), as implemented January 2, 2013. RoHS Declarations for this product can be obtained from your Cree representative or from the Product Documentation sections of www.cree.com.

REACH Compliance

REACH substances of high concern (SVHCs) information is available for this product. Since the European Chemical Agency (ECHA) has published notice of their intent to frequently revise the SVHC listing for the foreseeable future, please contact your Cree representative to ensure you get the most up-to-date REACH SVHC Declaration. REACH banned substance information (REACH Article 67) is also available upon request.

For more information, please contact:

4600 Silicon Drive
Durham, North Carolina, USA 27703
www.wolfspeed.com/power