



PS CONNECTOR

Connectors for tabs



Features

• **Secure locking, easy insertion**

The combination of terminal and housing provides easy mating onto the male tab. Unmating is also easy, by holding the housing while pulling, the contact lock spring is disengaged by the taper inside the housing. Should you accidentally pull the wire, the locking mechanism ensure that disengagement does not take place.

• **Stable contact performance**

The contact is designed with a large contact area to give stable performance, even when high current is applied.

• **Mis-insertion prevention mechanism and housing lance**

Inside the housing is a stopper that prevents mis-insertion, which ensures that someone will not mistakenly insert a contact in the housing. What's more, use of a housing lance means that only slight force is needed to insert a contact, even though the contact is held firmly in place.

Specifications

- Current rating: 25A AC, DC(#250 + AWG #10)
- Voltage rating: 250V AC, DC
- Temperature range: -40°C to +105°C
- Contact resistance: Initial value/ 3m Ω max.
After environmental testing/ 6m Ω max.
- Insulation resistance: 1,000M Ω min.
- Withstanding voltage: 2,000V AC/ minute
- Applicable wire: #110...AWG #24 to #16
#187...AWG #26 to #14
#205...AWG #22 to #14
#250...AWG #22 to #10
- Applicable Tab: #110 Tab 0.5mm(.020") thick
#187 Tab 0.5mm(.020")/0.8mm(.031") thick
#205 Tab 0.5mm(.020")/0.8mm(.031") thick
#250 Tab 0.8mm(.031") thick

*Contact JST for details.

Standards

 Recognized E60389

 Certified LR20812

 R9850196

PS CONNECTOR

Contact

#110 Series

SPS-01T-110

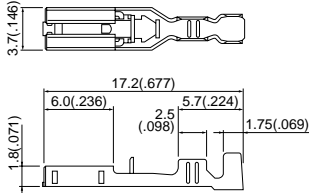

SPS-41T-110

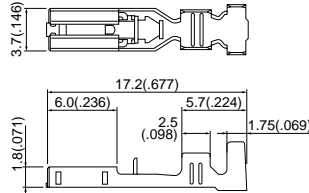

#187 Series

SPS-01T-187...for 0.5mm(.020") thick tabs

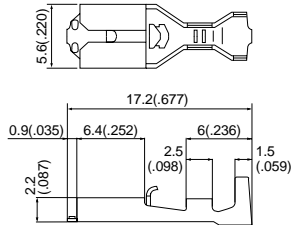

SPS-51T-187...for 0.5mm(.020") thick

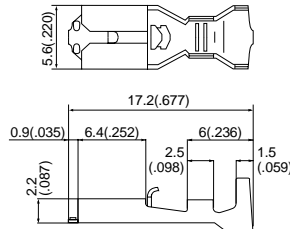

SPS-82T-187...for 0.5mm(.020")

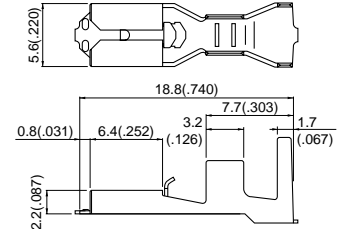

SPS-01T-187-8...for 0.8mm(.031") thick

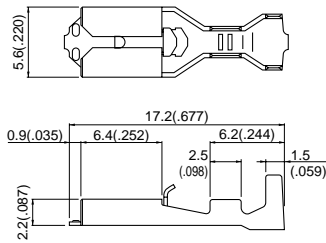

SPS-51T-187-8...for 0.8mm(.031") thick

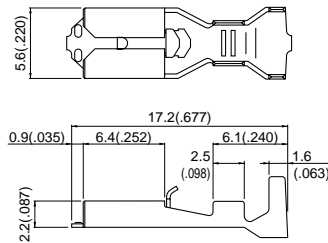

<Flag type>

SFPS-41T-187...for 0.5mm(.020")

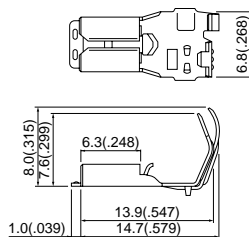

SFPS-41T-187-8...for 0.8mm(.031") thick

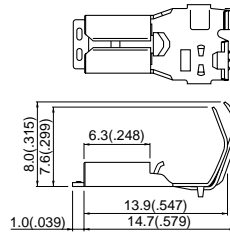

Contact

#205 Series

SPS-21T-205...for 0.8mm(.031") thick

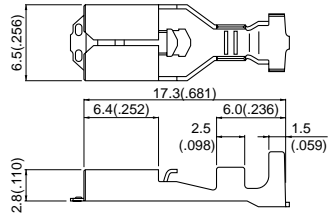

SPS-21T-205-5...for 0.5mm(.020") thick

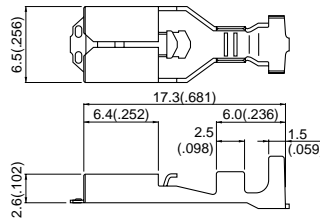

SPS-51T-205...for 0.8mm(.031") thick

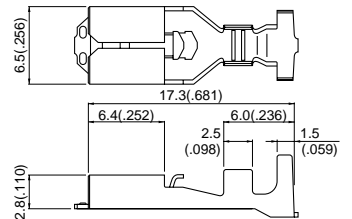

#250 Series

SPS-21T-250

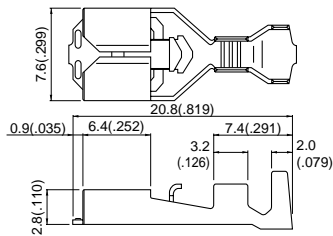

SPS-61T-250

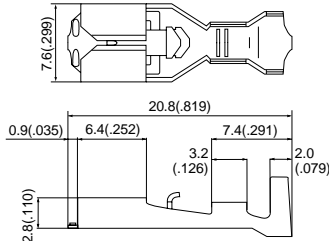

SPS-91T-250

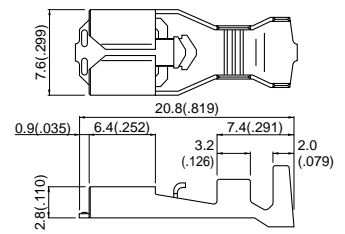

<Flag type>

SFPS-61T-250

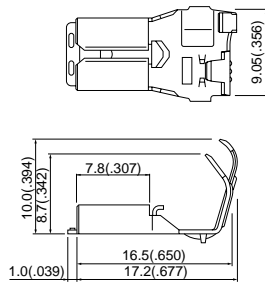

SFPS-91T-250

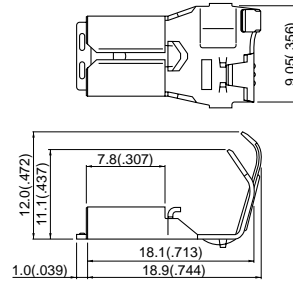

PS CONNECTOR

Contact

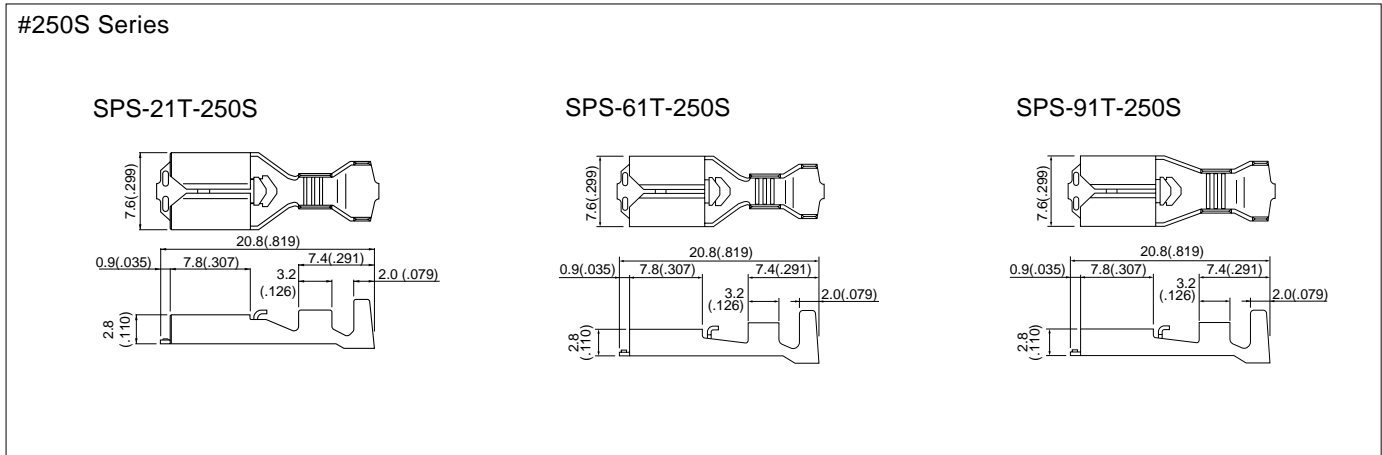

Series	Model No.	Applicable wire			Qty / reel
		mm ²	AWG #	Insulation O.D.mm(in.)	
#110	SPS-01T-110	0.21 to 0.5	24 to 20	1.0 to 2.5(.039 to .098)	10,000
	SPS-41T-110	0.5 to 1.25	20 to 16	1.9 to 3.4(.075 to .134)	10,000
#187	for 0.5mm(.020") thick tabs SPS-01T-187	0.13 to 0.5	26 to 20	1.3 to 3.4(.051 to .134)	10,000
	SPS-51T-187	0.5 to 2.0	20 to 14	1.9 to 3.6(.075 to .142)	7,500
	SPS-82T-187	0.75+0.75 to 1.25+1.25	18+18 to 16+16	2.1+2.1 to 2.9+2.9(.083+083 to .114+.114)	3,500
	for 0.8mm(.031") thick tabs SPS-01T-187-8	0.13 to 0.5	26 to 20	1.3 to 3.4(.051 to .134)	10,000
#187 flag	for 0.5mm(.020") thick tabs SFPS-41T-187	0.3 to 1.25	22 to 16	1.7 to 3.4(.067 to .134)	5,000
	for 0.8mm(.031") thick tabs SFPS-41T-187-8	0.3 to 1.25	22 to 16	1.7 to 3.4(.067 to .134)	5,000
#205	for 0.8mm(.031") thick tabs SPS-21T-205	0.3 to 0.75	22 to 18	1.5 to 3.1(.059 to .122)	5,000
	for 0.5mm(.020") thick tabs SPS-21T-205-5	0.3 to 0.75	22 to 18	1.5 to 3.1(.059 to .122)	5,000
	for 0.8mm(.031") thick tabs SPS-51T-205	0.5 to 2.0	20 to 14	1.9 to 3.6(.075 to .142)	5,000
#250	SPS-21T-250	0.3 to 0.75	22 to 18	1.5 to 3.1(.059 to .122)	5,000
	SPS-61T-250	0.75 to 2.0	18 to 14	2.1 to 3.9(.083 to .154)	5,000
	SPS-91T-250	2.0 to 5.5	14 to 10	3.0 to 4.7(.118 to .185)	4,000
#250 flag	SFPS-61T-250	0.75 to 2.0	18 to 14	2.1 to 3.9(.083 to .154)	3,000
	SFPS-91T-250	3.5 to 5.5	12 to 10	4.0 to 5.2(.157 to .205)	2,000
#250S	SPS-21T-250S	0.3 to 0.75	22 to 18	1.5 to 3.1(.059 to .122)	5,000
	SPS-61T-250S	0.75 to 2.0	18 to 14	2.1 to 3.9(.083 to .154)	5,000
	SPS-91T-250S	2.0 to 5.5	14 to 10	3.0 to 4.7(.118 to .185)	4,000

Material and Finish

Brass, tin-plated

Housing

#110 Series

PS-110

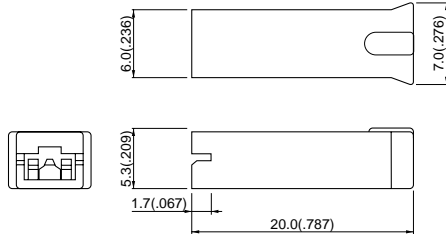

#187 Series

PS-187

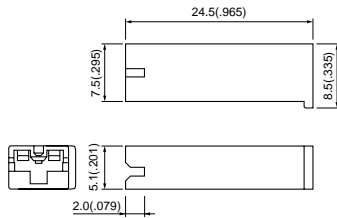

PS-187-2A-10

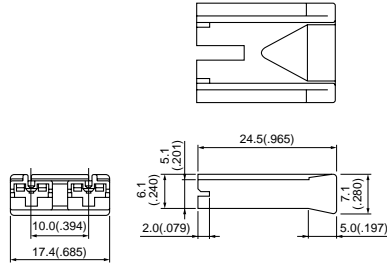

PS-187-2A-15

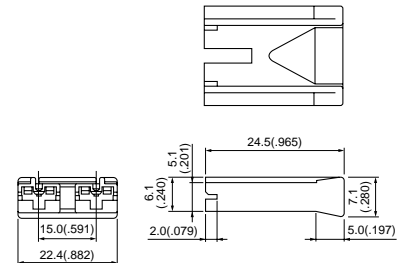

PS-187-2A-17.8

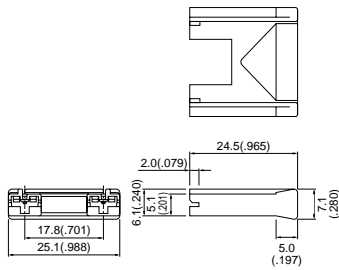

PS-187-2B

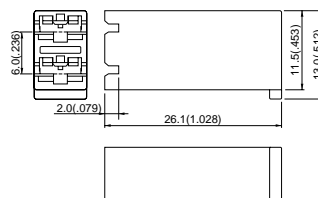

PS-187-2B-6.75

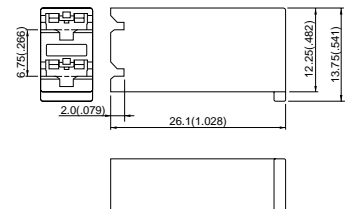

PS-187-2B1

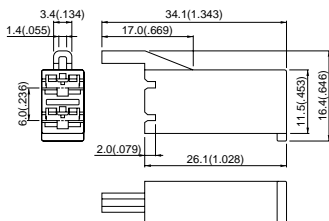

PS-187-4B

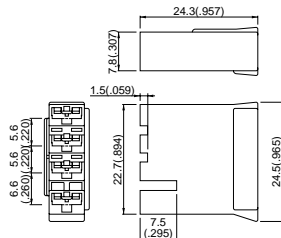

PS CONNECTOR

#187 Series

PS-187-2V

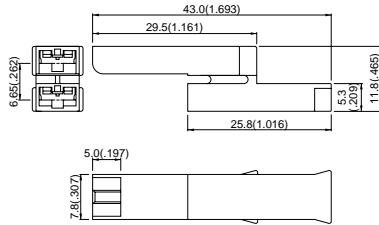

PS-187-3V

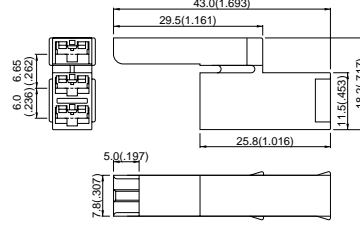

PS-187-8-T-H

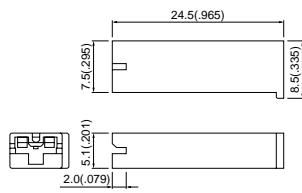

PS-187-2A-16-8-T-H

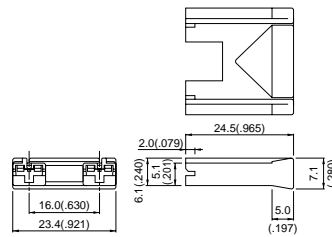

PS-187-2B-8-T-H

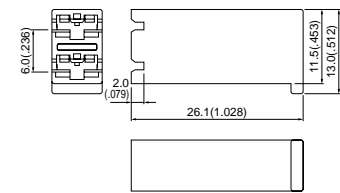

PS-187-2B1-8-T-H

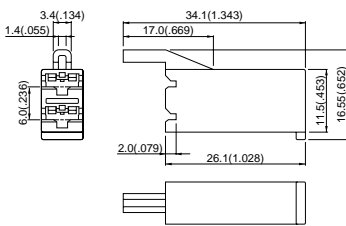

PS-187-2V-8-T-H

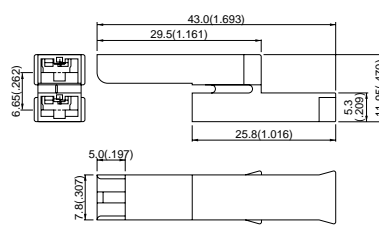

PS-187-3V-8-T-H

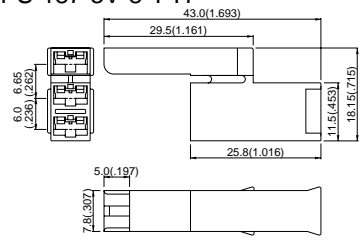

#250S Series

NPS-250-A

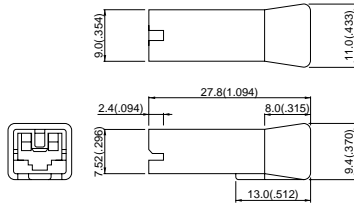

#250 Series

PS-250

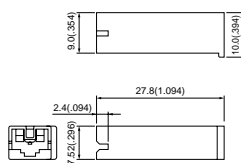

PS-250-A

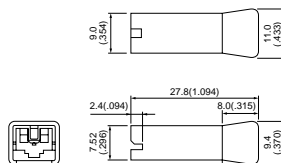

PS-250-2B

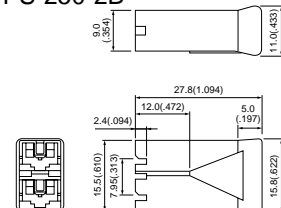

#250 Series

PS-250-2A-15

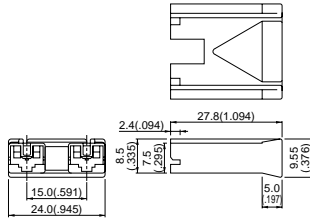

One-touch sleeve

FPS-187

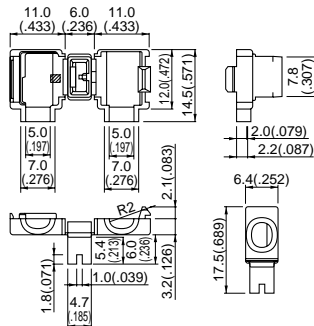

FPS-250

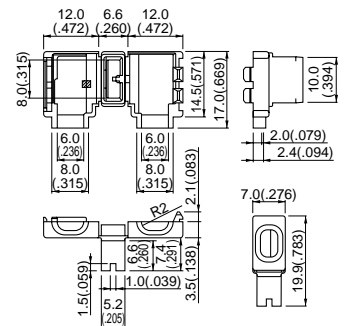

Series	Model No.	Q'ty / bag	Applicable terminal
#110	PS-110	1,000	SPS-01T-110, SPS-41T-110
	PS-187	1,000	
	PS-187-2A-10	1,000	
	PS-187-2A-15	500	
	PS-187-2A-17.8	500	
	PS-187-2B	500	SPS-01T-187
	PS-187-2B-6.75	500	SPS-51T-187
	PS-187-2B1	500	SPS-82T-187
	PS-187-4B	500	
	PS-187-2V	500	
	PS-187-3V	500	
	*PS-187-8-T-H	1,000	
	*PS-187-2A-16-8-T-H	500	
*PS-187-2B-8-T-H	500	SPS-01T-187-8	
*PS-187-2B1-8-T-H	500	SPS-51T-187-8	
*PS-187-2V-8-T-H	500		
*PS-187-3V-8-T-H	500		
#250S	NPS-250-A	1,000	SPS-21T-250S
			SPS-61T-250S
			SPS-91T-250S
#250	PS-250	1,000	SPS-21T-250
	PS-250-A	500	SPS-61T-250
	PS-250-2B	500	SPS-91T-250
	PS-250-2A-15	500	
One-touch sleeve	FPS-187	500	SFPS-41T-187
	FPS-250	500	SFPS-61T-250

Material and Finish

Nylon 66, UL94V-0, natural (white)

UL94V-2, gray <*-marked housing...for 0.8mm(.031") thick tabs>

Note: FPS-187 and FPS-250 are UL recognized with File No. E55167, but not CSA certified.

PS CONNECTOR

Applicable tab

#110...for 0.5mm(.020")

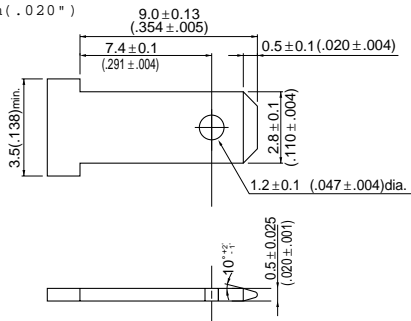

#187...for 0.5mm(.020") thick

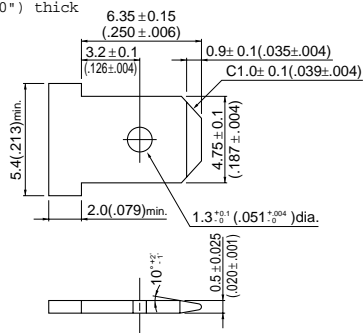

#187...for 0.8mm(.031") thick tabs

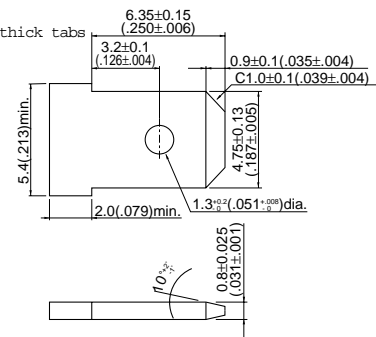

#205...for 0.8mm(.031") thick

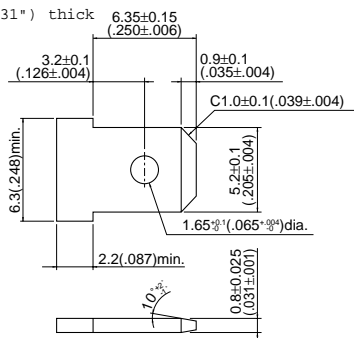

#250...for 0.8mm(.031") thick

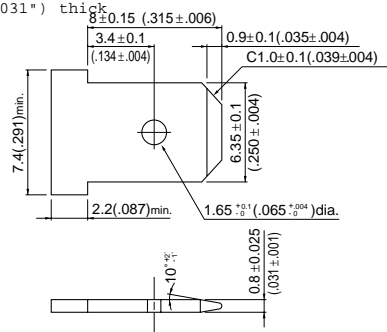

Note: Make sure there are no unneeded ribs or other protuberances on tab surfaces.

Applicator for the semi-automatic press AP-K2N

Contact	Crimp applicator MK-L(-SPS)	
	with safety cover	without safety cover
SFPS-41T-187(-8)	APL SFPS41-187 WSC	APL SFPS41-187
SFPS-61T-250	APL SFPS61-250 WSC	APL SFPS61-250
SFPS-91T-250	APL SFPS91-250 WSC	APL SFPS91-250
SPS-01T-110	APLMK SPS01-110	APLNC SPS01-110
SPS-01T-187(-8)	APLMK SPS01-187	APLNC SPS01-187
SPS-21T-205	APLMK SPS21-205	APLNC SPS21-205
SPS-21T-250	APLMK SPS21-250	APLNC SPS21-250
SPS-21T-250S	APLMK SPS21-250	APLNC SPS21-250
SPS-41T-110	APLMK SPS41-110	APLNC SPS41-110
SPS-51T-187(-8)	APLMK SPS51-187	APLNC SPS51-187
SPS-51T-205	APLMK SPS51-205	APLNC SPS51-205
SPS-61T-250	APLMK SPS61-250	APLNC SPS61-250
SPS-61T-250S	APLMK SPS61-250	APLNC SPS61-250
SPS-82T-187	APLMK SPS82-187	APLNC SPS82-187
SPS-91T-250(S)	APLMK SPS91-250	APLNC SPS91-250